



Instruction Manual

MB90 Moisture Analyzer

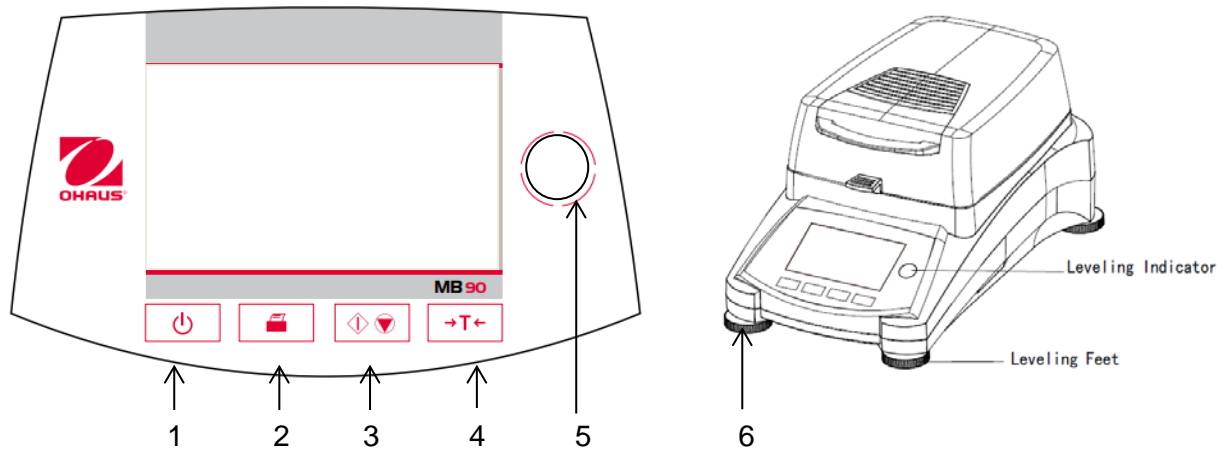







Table of Contents

1. GETTING TO KNOW YOUR MOISTURE ANALYZER	4
1.1 Introduction	4
1.2 Overview of the Moisture Analyzer	4
1.3 What is a Moisture Analyzer?	4
2. SAFETY INFORMATION.....	5
2.1 Definition of Signal Warnings and Symbols	5
2.2 Product Specific Safety Notes	6
3. INSTALLATION	8
3.1 Unpacking and checking the standard equipment.....	8
3.2 Selecting the Location.....	8
3.3 Installing the Tray Pan, Draft Shield and Pan Support	9
3.4 Leveling the Moisture Analyzer.....	9
3.5 Connecting to a Power Supply	10
3.6 Switching the Moisture Analyzer on and off.....	11
4. MAKING A SIMPLE MEASUREMENT	14
5. MENU.....	14
6. SETUP	15
6.1 Lock Out.....	15
6.2 Adjustment.....	16
6.2.1 Weight Adjustment	16
6.2.2 Temperature adjustment	17
6.2.3 Weight adjustment record	17
6.2.4 Temperature adjustment record	19
6.3 User settings	20
6.3.1 Language	20
6.3.2 Brightness	21
6.3.3 Sound	22
6.4 Device settings.....	22
6.4.1 Date and Time.....	22
6.4.2 Peripherals	24
6.4.3 Print	25
6.4.4 GLP and GMP Data	26
6.4.5 Touch screen adjustment.....	26
6.5 System and data management.....	28
7. METHOD LIBRARY	33
7.1 Method load, edit and delete.	33

7.2	Entering Method Name	33
7.3	Setting the Drying Profile	34
7.4	Setting the Drying Temperature.....	34
7.5	Selecting the switch-off criterion	35
7.6	Displayed result	35
7.7	Target Weight	36
7.8	Starting Mode.....	37
7.9	Default method.....	37
7.10	Method export and import.....	37
8.	RESULTS	39
9.	HELP INFORMATION	42
10.	PRINTING TEST DATA.....	42
10.1	RS232 Command Table	44
10.2	RS232 Pin out.....	45
11.	CARE AND MAINTENANCE	46
11.1	Cleaning Interior/Exterior Components	46
11.2	Replacing Power Line Fuse.....	48
11.3	Troubleshooting.....	48
11.4	Error detection	49
11.5	Service information.....	50
11.6	Accessories.....	50
12.	TECHNICAL DATA.....	50
12.1	Admissible ambient conditions	50
12.2	Specifications.....	51
13.	COMPLIANCE	51

Overview of Controls



1		Turns On or Off display and fan.
2		When pressed, sends Print command.
3		When pressed, either starts or stops the drying process.
4		When pressed, performs Tare function.
5		Leveling indicator
6	Leveling Feet	Used to level the Moisture Analyzer.

1. GETTING TO KNOW YOUR MOISTURE ANALYZER

This section provides you with essential information on your MB90 Moisture Analyzer. Please read through the section carefully even if you have previous experience with OHAUS Moisture Analyzers and be sure to familiarize yourself with the safety notes.

1.1 Introduction

Thank you for deciding to purchase an MB90 Halogen Moisture Analyzer from Ohaus. Behind your instrument stands OHAUS, a leading manufacturer of precision Moisture Analyzers, Balances, Scales and Indicators. An Aftermarket Department with trained instrument technicians is dedicated to provide you with the fastest service possible in the event your instrument requires servicing. OHAUS also has a Customer Service Department to answer any inquiries regarding applications and accessories.

To ensure you make full use of the possibilities offered by your Moisture Analyzer, please read the manual completely before installation and operation.

You can also find and download the instruction manual at <http://dmx.ohaus.com/WorkArea/showcontent.aspx?id=4294974535>

1.2 Overview of the Moisture Analyzer

The Moisture Analyzer offers a high level of operating convenience and useful functions to make accurate measurements.

The Moisture Analyzer has the following features:

- Fully programmable with colorful touch screen
- Extremely rugged and chemically resistant construction.
- Ergonomic operating controls and a large, easily readable display.
- Easy to follow menus for simplified operation.
- Built-in functions for manual, automatic timing, printing intervals.
- Built-in selectable drying profiles.
- Built-in library stores 2 samples complete with setup parameters and statistics.
- Built-in RS232 and USB interface.
- Any of thirteen languages (English, Spanish, French, German, Italian, Russian, Polish, Czech, Hungarian, Portuguese, Chinese, Japanese, Korean)
- Display contains all test data during drying process.
- A variety of optional accessories includes disposable pan liners, temperature calibration kit, interface communication cables, printer, and a security device.

1.3 What is a Moisture Analyzer?

The Ohaus Halogen Moisture Analyzer can be used to determine the moisture content of practically any substance. The instrument operates on the thermogravimetric principle: At the start of the measurement, the Moisture Analyzer determines the weight of the sample; the sample is then quickly heated by the integral halogen dryer unit and moisture vaporizes. During the drying operation, the instrument continuously determines the weight of the sample and displays the result. On completion of drying, result is displayed as % moisture content, % solids, weight or % regain.

Of particular importance in practice is the rate of heating. In comparison with conventional infrared heating or the drying oven method, for example, the halogen dryer of your instrument needs a shorter time to reach its maximum heating power. It also allows the use

of high temperatures; an additional factor in shortening the drying time. Response times for the control of production are shorter resulting in increased productivity.

All parameters of a measurement (drying temperature, drying time, etc.) can be pre-selected. The Moisture Analyzer offers many other possibilities. A few of these are listed here:

- The integrated database for drying procedures stores the settings for your samples.
- The drying characteristics can be matched to the type of sample.
- Your settings and measurement results can be recorded and stored.
- Built-in battery backup stores valuable data during a power failure.

Even though the Moisture Analyzer contains many functions, operation remains simple. The four button controls on the front panel for the frequently usage: Power on/off, Print, Start/Stop and Tare. The 4.3" color touch screen allows entry into a variety of displays which includes a test library where previous samples are recorded along with the test parameters so that a similar sample can be run without the need to enter all new data. The color touch screen also indicates the method name, selected temperature, actual temperature, time and moisture content in percent, solids in percent, grams, % regain and a graphical display which illustrates the time and percentage.

Your Moisture Analyzer conforms with all common standards and directives. It supports standard procedures, work techniques and records as required by **GLP (Good Laboratory Practices)** and **SOP (Standard Operating Procedure)**. We recommend the use of the OHAUS SF40A Printer.

2. SAFETY INFORMATION





2.1 Definition of Signal Warnings and Symbols

Safety notes are marked with signal words and warning symbols. These show safety issues and warnings. Ignoring the safety notes may lead to personal injury, damage to the instrument, malfunctions and false results.

Signal Words

- WARNING** for a hazardous situation with medium risk, possibly resulting in severe injuries or death if not avoided.
- CAUTION** for a hazardous situation with low risk, resulting in damage to the device or the property or in loss of data, or minor or medium injuries if not avoided.
- Attention** (no symbol) for important information about the product.
- Note** (no symbol) for useful information about the product.

Warning Symbols

	General hazard		Electrical shock
	Hot surface		Inflammable or explosive substance



2.2 Product Specific Safety Notes

General Safety Information

Your instrument meets the state of the art technology and complies with all recognized safety rules, however, certain hazards may arise in extraneous circumstances. Do not open the housing of the instrument: It does not contain any parts which can be maintained, repaired or replaced by the user. If you ever have problems with your instrument, contact your authorized OHAUS dealer or service representative.

Always operate and use your instrument only in accordance with the instructions contained in this manual. The instructions for setting up your new instrument must be strictly observed.

If the instrument is not used according to these Operating Instructions, protection of the instrument may be impaired and OHAUS assumes no liability.

Intended Use

Your Moisture Analyzer is used for determining the moisture in samples. Use the instrument exclusively for this purpose. Any other type of use and operation beyond the limits of technical specifications without written consent from OHAUS, is considered as not intended. Moisture determination applications must be optimized and validated by the user according to local regulations. Application-specific data provided by OHAUS is intended for guidance only.



It is not permitted to use the instrument in explosive atmosphere of gases, steam, fog, dust and flammable dust (hazardous environments).

Staff Safety

The Moisture Analyzer may be operated only by trained personnel who are familiar with the properties of the samples used and with the handling of the instrument.

In order to use the instrument, you must have read and understood the operating instructions. Keep the operating instructions for further reference.

Never make any modifications to the instrument and use only original spare parts and optional equipment from OHAUS.

Protective Clothing

It is advisable to wear protective clothing in the laboratory when working with the instrument.



A lab coat should be worn.



A suitable eye protection such as goggles should be worn.



Use appropriate gloves when handling chemicals or hazardous substances, checking their integrity before use.

Safety Notes



WARNING

Risk of electric shock

Your instrument is supplied with a 3-pin power cable with an equipment grounding conductor. Only extension cables which meet this relevant standards

and also have an equipment grounding conductor may be used. Intentional disconnection of the equipment grounding conductor is prohibited.



CAUTION

The Halogen Moisture Analyzer works with heat!

- a) Ensure sufficient free space around the instrument to avoid heat accumulation and overheating (approx. 1 m free space above the heating module).
- b) The vent over the sample must never be covered, plugged, taped over or tampered with in any other way.
- c) Do not place any combustible materials on, under or next to the instrument since the area around the heating module may be hot.
- d) Exercise caution when removing the sample. The sample itself, the sample chamber, the draft shield and any sample vessels used may still be very hot.
- e) During operation, you should never open the heating module itself as the ring-shaped heating reflector or its protective glass can reach 400 °C! If you have to open the heating module e.g. for maintenance, disconnect the instrument from the power supply and wait until the heating module has cooled down completely.
- f) No modifications must be made within the heating module. It is particularly dangerous to bend any components or remove them or to make any other changes.

Certain samples require special care!

With certain types of samples, there is a possibility of danger to personnel or damage of property.

Please note that the user always has the responsibility and liability for damage caused by use of any types of samples!



CAUTION

Fire or Explosion

- Flammable or explosive substances.
 - Substances containing solvents.
 - Substances which evolve flammable or explosive gases or vapors when heated.
- a) In cases of doubt, perform a careful risk analysis.
 - b) Work at a drying temperature that is low enough to prevent the formation of flames or an explosion.
 - c) Wear protective goggles.
 - d) Work with small amounts of sample.
 - e) **Never leave the instrument unattended!**



WARNING

Substances which contain toxic or caustic components

Toxic gases produced during drying could cause irritations (eyes, Skin, breathing), illness or death.

- Such substances may be dried only in a fume cupboard.



CAUTION

Corrosion

Substances which evolve corrosive vapors when heated (e.g. acids).

- Work with small amounts of samples as the vapor can condense on cooler housing parts and cause corrosion.

3. INSTALLATION

In this section, you will learn how you unpack and install your new Moisture Analyzer and prepare it for operation. On completion of the steps described in this section, your Moisture Analyzer is ready for operation.

3.1 Unpacking and checking the standard equipment

Open the package and remove the instrument and the accessories. Check the completeness of the delivery.

The following accessories are part of the standard equipment of your new Moisture Analyzer.

- 1 Box, Aluminum sample pans
- 1 Pan support
- 1 Glass fiber Pad
- 1 Draft shield
- 1 Tray Pan
- 1 Power cable
- 1 Pan Handle
- 1 Spoon
- 1 Quick Guide

Remove packing material from the instrument.

Check the instrument for transport damage. Immediately inform your Ohaus dealer if you have complaints or parts are missing.

Store all parts of the packaging. This packaging guarantees the best possible protection for the transport of your instrument.

3.2 Selecting the Location

The Moisture Analyzer should always be used in an environment which is free from excessive air currents, corrosives, vibration, and temperature or humidity extremes. These factors will affect displayed weight readings.

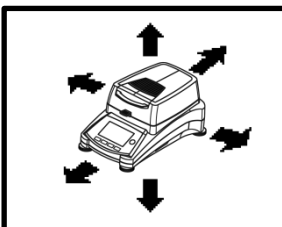
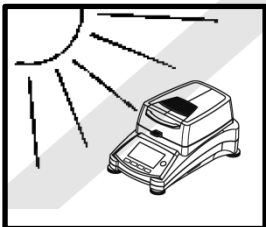
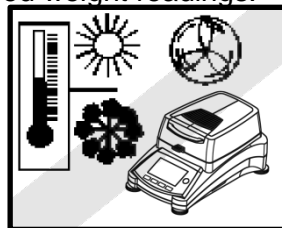
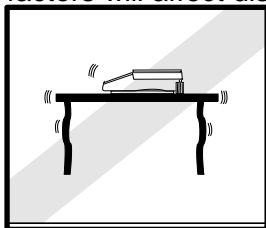

DO NOT install the Moisture Analyzer:

- Next to open windows or doors causing drafts or rapid temperature changes.
- Near air conditioning or heat vents.
- Near vibrating, rotating or reciprocating equipment.
- Near magnetic fields or equipment that generate magnetic fields.
- On an unlevel work surface.
- In confined areas, allow sufficient space around the instrument for ease of operation and keep away from radiating heat sources.

3.3 Installing the Tray Pan, Draft Shield and Pan Support

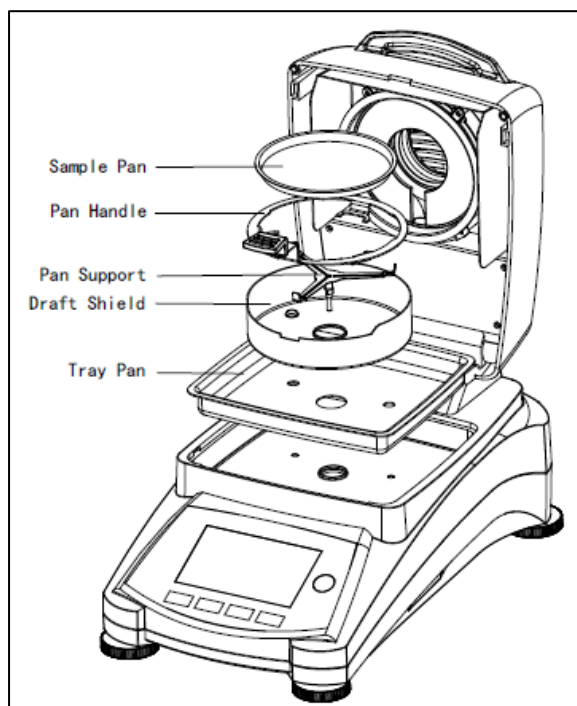

Lift the cover straight up and install the tray pan in the base of the heating chamber.

Install the draft shield (only one position possible) on top of the tray pan.

Install the pan support into position. Turn the pan support until it engages. In the locked position, the arm of the pan support points directly towards the front of the analyzer.

3.4 Leveling the Moisture Analyzer

Exact horizontal positioning and stable installation are prerequisites for repeatable results. To compensate for small irregularities or inclinations at the location, the instrument can be leveled.

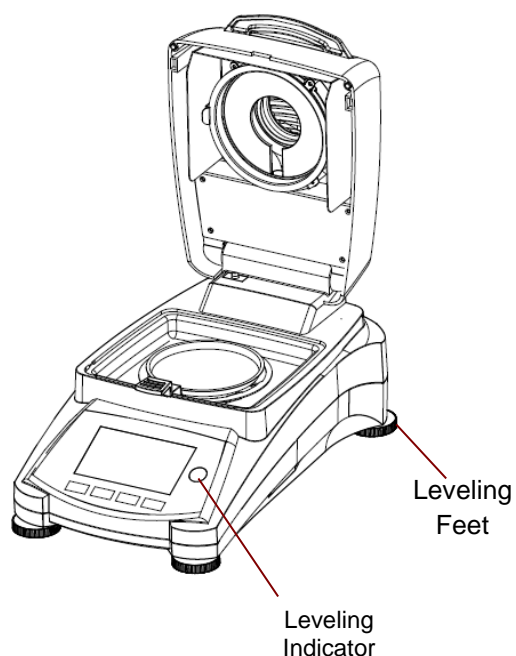

Adjust the leveling feet of the Moisture Analyzer until the air bubble in the indicator is centered. The level indicator is located under the cover towards the rear of the Moisture Analyzer.

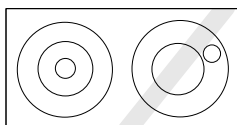

Attention: The instrument should be leveled each time its location is changed.

3.5 Connecting to a Power Supply



WARNING: Risk of electric shock.

- Use only the 3-pin power cord with equipment grounding connector which was supplied with your instrument. Only connect the power cord to a 3-pin ground outlet.
- Only extension cords which meet the relevant standards and also have an equipment grounding conductor may be used.

Attention:

Check to ensure the voltage stated on the Moisture Analyzer's data label matches your local line voltage. If this is not the case, do not connect the Moisture Analyzer to the power supply, contact your responsible OHAUS dealer.

The halogen dryer unit is designed to operate at a specific line voltage (90V AC or 240V AC). The dryer unit is installed at the factory and is matched to the particular line voltage of the country of destination.

Connection to a line voltage that is too high can lead to burning out the halogen heater, whereas, a supply voltage that is too low will prolong the drying process and the instrument may not operate properly.

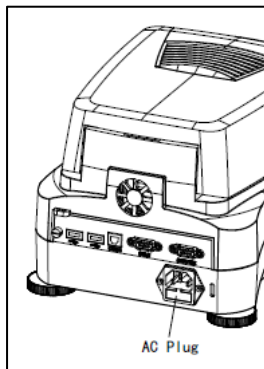

Connect the power cord to the power supply socket located at the rear of the Moisture Analyzer and to the power supply outlet. The Moisture Analyzer becomes operational as soon as power is applied. The display will remain off until the **On/Off** button is pressed.

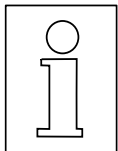

Allow the Moisture Analyzer to warm up for at least 30 minutes to enable it to adapt itself to the ambient conditions. If the Moisture Analyzer has been stored in a very cold environment before installation, it may require several hours for it to stabilize.



WARNING:

If the power cable supplied is not long enough, use only a **proper 3-pin extension cable with an equipment grounding connector**.

3.6 Switching the Moisture Analyzer on and off

Your Moisture Analyzer is on at all times when connected to a power source. The display can be turned on or off.



To **switch the Moisture Analyzer on**, press the **On/Off** button. An internal diagnostic test is performed; the display lights and the Home screen appears followed by the initial display.

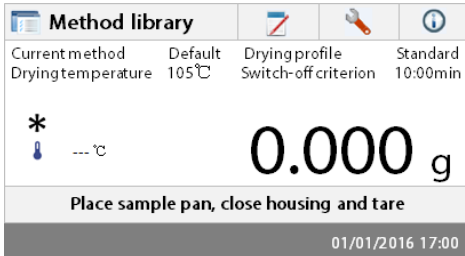

To **switch the Moisture Analyzer off**, press the **On/Off** button. After the analyzer has been switched off, it is in the standby mode. If you wish to perform a test, press the **On/Off** button again.

Note:

As your Moisture Analyzer needs no warm-up time when in the standby mode and is immediately ready for testing samples, we advise you to switch the display off by use of the On/Off button and not to disconnect it from the power supply. This also ensures that the Moisture Analyzer is always in thermal equilibrium.

4. MAKING A SIMPLE MEASUREMENT

With your Moisture Analyzer powered on, you are ready to operate for the first time and perform a simple measurement. For this simple test, you will enter the Default method and enable the test. By doing this test, you will become familiar with the instrument.

Included with your Moisture Analyzer is a specimen sample for your first measurement. This sample is an absorbent glass fiber pad. During your first measurement, the instrument operates with the factory settings.



If the display is not visible and the unit is plugged into a power source, press the On/Off button.

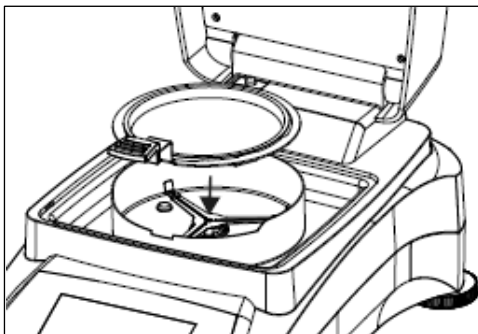

Directly start a measurement.

Open the cover on the Moisture Analyzer.
Clean the pan.

Place the pan handle in the sample chamber. Ensure that the tongue of the pan handle fits exactly in the slot of the draft shield element.

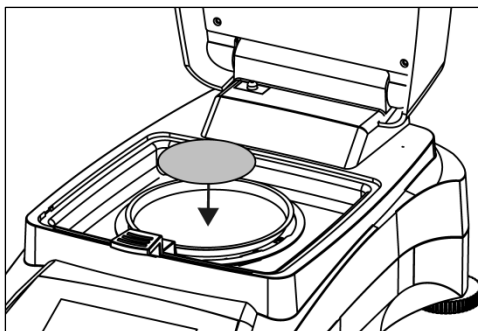

Place the empty sample pan and glass fiber pan in the pan handle. The sample pan must lie flat in the pan handle.

Attention: It is advisable for you to work with the pan handle at all times. The pan handle is ergonomic, safe and provides protection against possible burns due to a hot sample pan.

Close the cover. This sets the Moisture Analyzer to zero automatically.

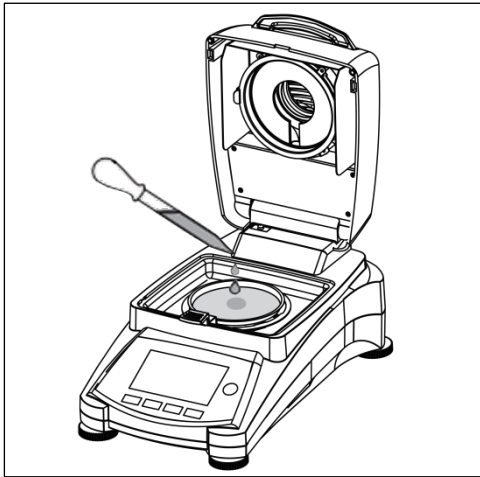

Open the cover on the Moisture Analyzer.

Wet the glass fiber pan with a 0.5 to 1 gram of water.
Attention: Minimum sample size must be greater than 0.5 gram.

Starting the test

Close the cover, the Moisture Analyzer starts the drying and measurement process automatically.

Drying and measurement

You are now able to follow the progress of the drying cycle on the display. This first display comes up automatically when the test was started.

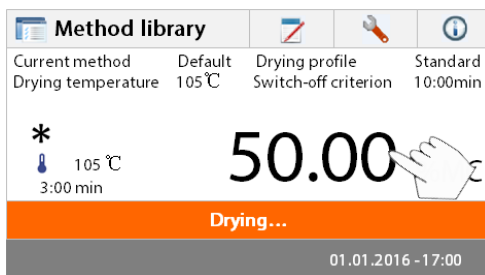

Observing the test progress

There are two displays available when the Moisture Analyzer is running a test. One showing the %MC value and another showing a curve.

When pressing the data area while %MC is shown, the display will switch to show the curve. Likewise, pressing the data area again will switch back to show the %MC value.

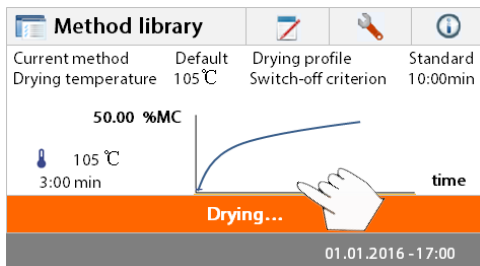

The display indicates the Method Name, Temperature/Time, actual temperature, elapsed time duration of the test, moisture and curve. The test automatically stops at the end of the measurement. If you want to end the test sooner, press the button.

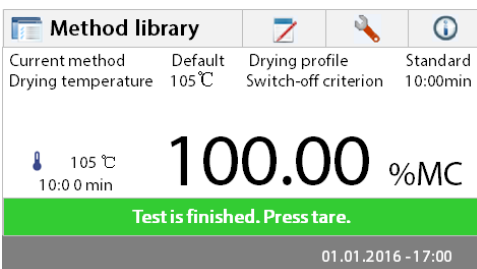

Congratulations! You have just performed your first measurement with your moisture analyzer.

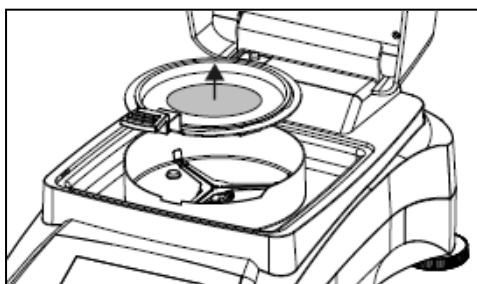

CAUTION: Danger of burns. Sample, sample pan and sample pan holder may still be hot.

Open the cover and carefully remove the sample pan handle from the drying area.

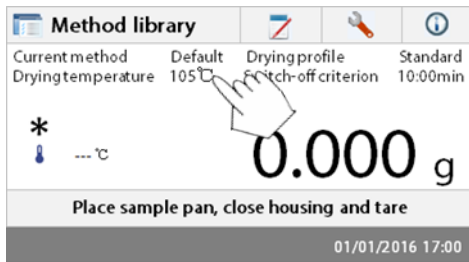

The analyzer comes with a default method preinstalled. The settings of the default method are shown on the display. To edit the settings, press on the area where the settings are displayed as shown to the left.

Default		
Method name	Default	▲
Drying profile	Standard	■
Drying temperature	105°C	
Switch-off criterion	10:00 min	
Display result	%MC	▼
Back		

Press the setting items to edit them. Please see section 7 for more details.

5. MENU

The Home screen appears after the moisture analyzer has been switched on.

1	2	3	4	
				Button area
Current method		Drying profile		Current Method
Default		Standard		
Drying temperature 105°C		Switch-off criterion 10:00min		
				Results area
Place sample pan, close housing and tare				Instructions area
01/01/2016 17:00				Date and time area

- 1. Method library: Change parameters and create new method.
- 2. Test results: Manage test results.
- 3. Setup: Change system settings.
- 4. Help information: Help information.

Method Library

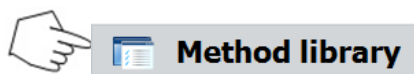

Press the Method library button to access the Method library menu.



The test library contains 2 methods. All methods which were previously entered can be recalled and the parameters for the recalled method when selected will be repeated.

Test Results



Press the Test results button to access the test results menu.



The Test results contains up to 100 test results. All results can be recalled, sorted and displayed statistically.

Setup



Press the Setup button to access the Setup menu.

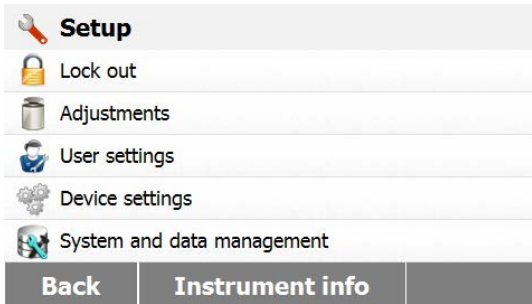

Help Information



Press the Help button to access the Help menu.



6. SETUP

The setup menu is activated by pressing the Setup button. The menu contains: lock out, weight and temperature adjustment, user settings, device settings, system and data management. Please review this entire section and the rest of the manual before making changes to the Analyzer. A description of each menu item and procedure follows:

6.1 Lock Out

Selecting this entry, then setting Lock Out to ON locks out all changes from the Method Library, Result, Setup, method and system data management. You would use this function after the Analyzer has been put into operation, and you do not want to change any of the test or analyzer setup parameters. "Lock Out" is intended to protect against accidental menu changes.



Press Setup button to access the Setup menu.

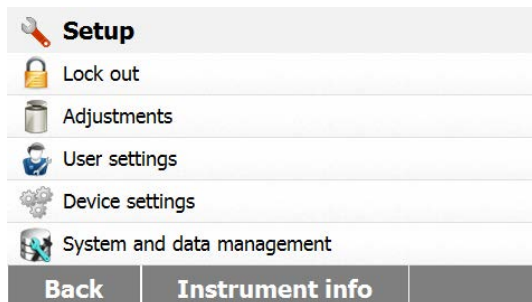

Press **Back** to return to Home screen.



Press **Lock out** to access the lock out menu.



Lock out will limit access to menus and saved settings/tests.



Press **Lock** to lock out
Press **Unlock** to release.

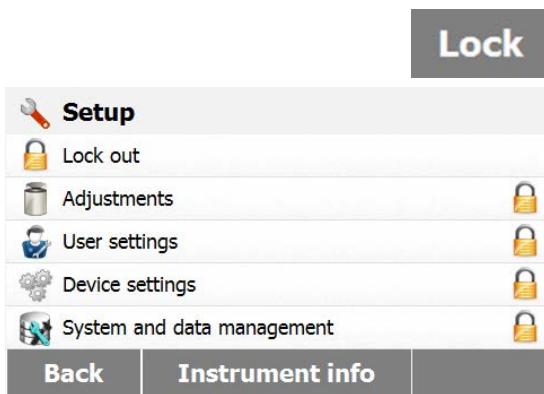

6.2 Adjustment

6.2.1 Weight adjustment

The Moisture Analyzer can be adjusted with an external mass of 50 grams. Adjustment of the Moisture Analyzer is not absolutely necessary for a correct moisture determination as the measurement is relative. The balance determines the weight of the sample before and after drying and the moisture is calculated on the basis of the ratio between wet and dry weights. Nevertheless, you should adjust the built-in balance under the following conditions:

- If this is stipulated by your quality assurance system (GLP, GMP, ISO 9001).
- If you suspect the analyzer has been abused.

To adjust the analyzer, processed as follows:



Press Setup button to access the Setup menu.

Press **Back** to return to Home screen.

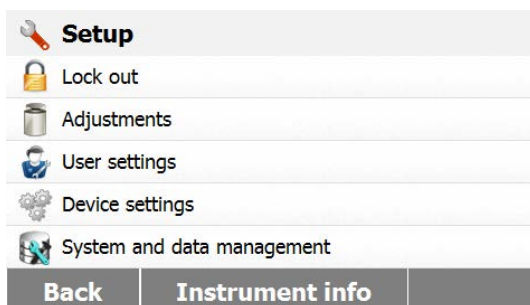



Press the Adjustment button to access adjustment menu.

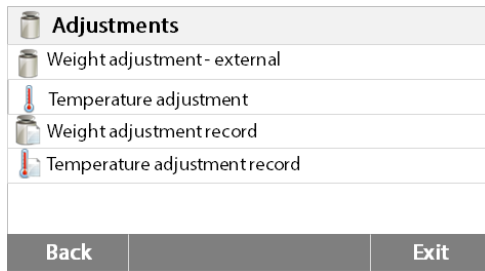

Press **Back** to return to previous step.

Press the Weight adjustment-external button

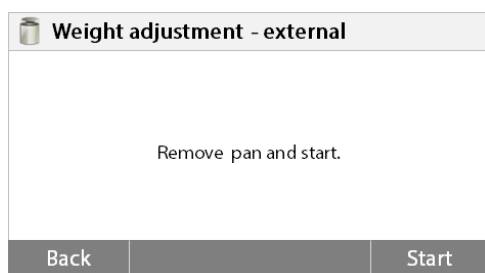

The display highlights the action you should take.

Follow the instructions on the display. Remove the sample pan. Place the required weight on the sample pan, close the cover. The display indicates if the adjustment was successful.

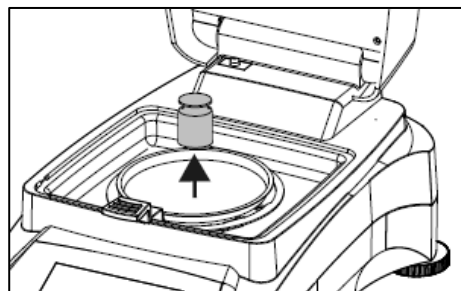
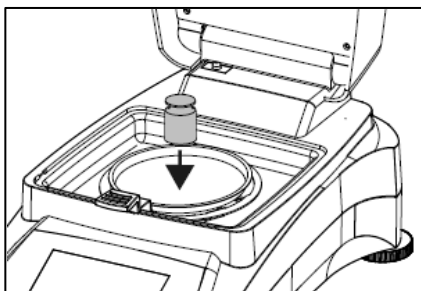

6.2.2 Temperature adjustment

You must have a temperature calibration kit to perform this procedure. If the Moisture Analyzer has been recently used, allow at least 30 minutes before performing adjustment.

Note: The temperature calibration kit is available as optional equipment.



Press Setup button to access the adjustment menu.

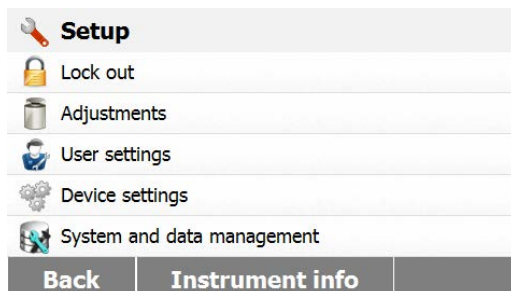

Press **Back** to return to Home screen.



Press adjustment button.

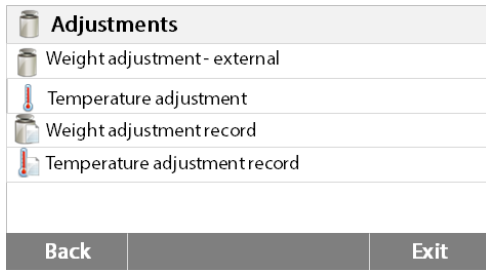

Press **Back** to return to previous screen.
Press **Exit** to return to Home screen.



Press Temperature adjustment button.

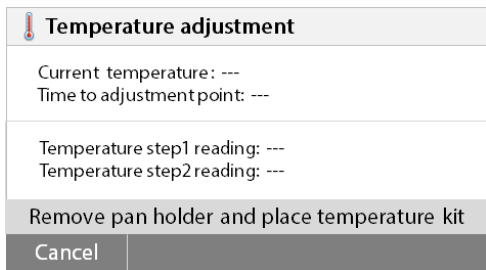

You are now prompted to remove the pan support. Place a temperature calibration kit and close the upper housing.

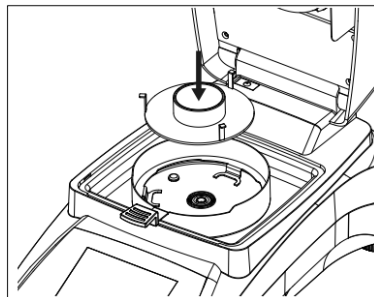

Press the **Start** to initiate the temperature adjustment process. Follow the screen prompts throughout the process.

The dryer unit is heated to a temperature of 100°C. You can observe the progress on the display as the dryer temperature and count down period are displayed. After 15 minutes, read the thermometer through the inspection window on the cover and enter this temperature. Adjust the display reading to agree with the thermometer, then press the **Enter** button. You have 15 minutes to make this adjustment, otherwise the adjustment is terminated.

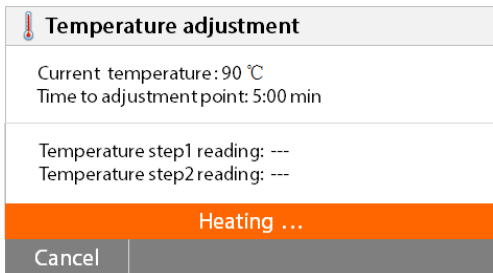

This is a two-point adjustment (100°C and 160°C). The dryer unit now heats to the second temperature (160°C). Adjustment of the temperature is defined by two points. Proceed exactly as you did for the first temperature. After you have set the display to agree with the thermometer, then press the **Enter** button.

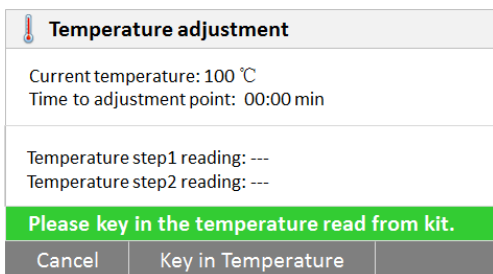



CAUTION: Danger of burns.

Be careful when removing the temperature calibration kit from the dryer unit as it can be very hot. Allow it to cool down by opening the cover before removing.

Remove the calibration kit. Replace the pan support in its proper positions.

6.2.3 Weight adjustment record

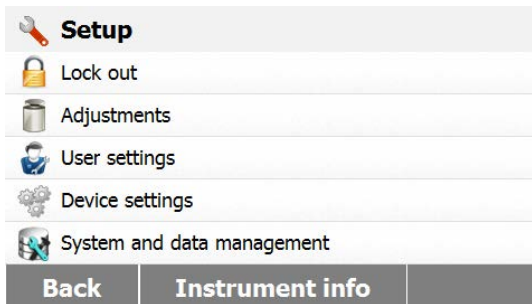

Press Setup button to access the Setup menu.

Press **adjustment** to access the adjustment menu.

Press **Back** return to **Home** screen.

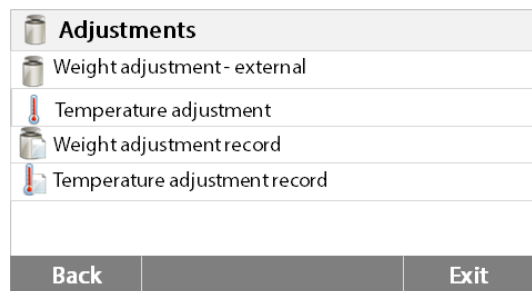

Press **Weight adjustment record** to list the weight adjustment record data.

Press **Back** to previous step.

Press **Exit** return to **Home** screen.

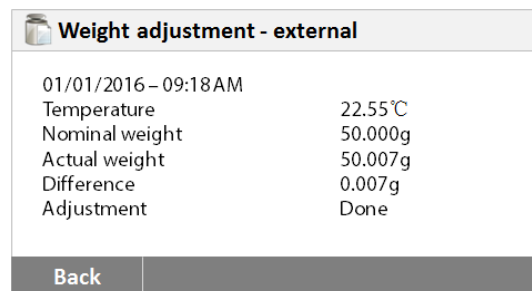

6.2.4 Temperature adjustment record

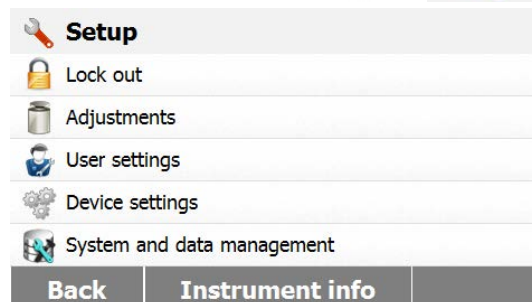

Press Setup button to access the Setup menu.

Press **Back** to return to Home Screen.

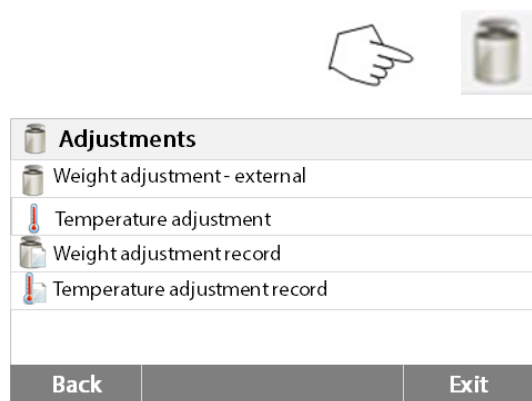

Press Weight and temperature adjustment button to access the adjustment screen. Press **Back** to return to previous screen. Press **Exit** to return to Home screen. Press the Temperature adjustment history button.

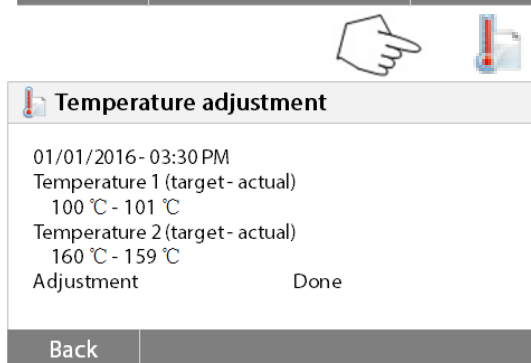

Here you will find the last temperature adjustment result. Press **Back** to return to previous screen.

6.3 User settings

6.3.1 Language

For convenience, the Moisture Analyzer is equipped with thirteen languages available on all displays. The following steps show how to set a language.

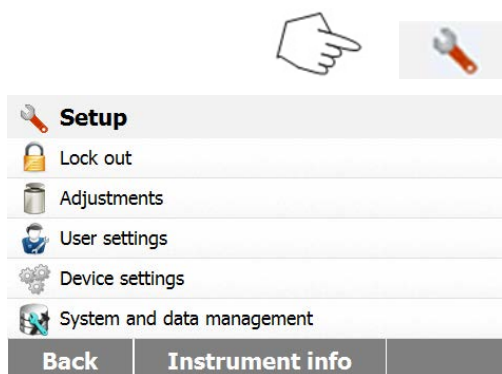

Press Setup button to access the Setup screen.

Press **Back** to return to Home screen.

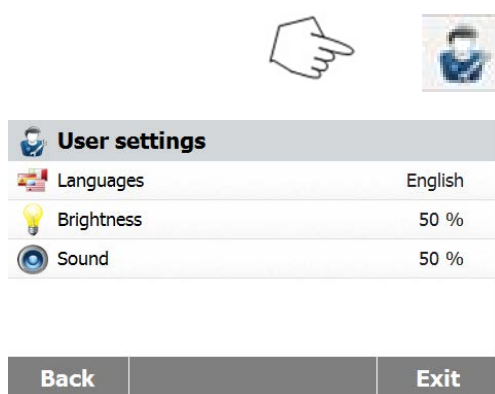

Press **User settings** to access the user settings menu.

Press **Language** to set language.

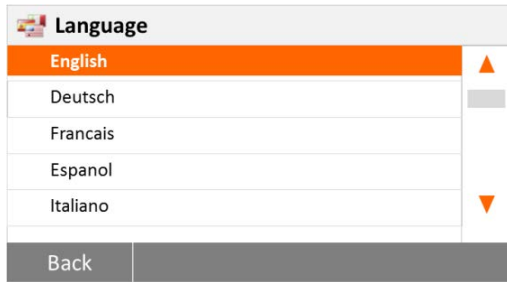

Select LANGUAGE.

Note: If you select English as the dialog language, the date format is changed and appears on all records in the MM/DD/YYYY format.

6.3.2 Brightness

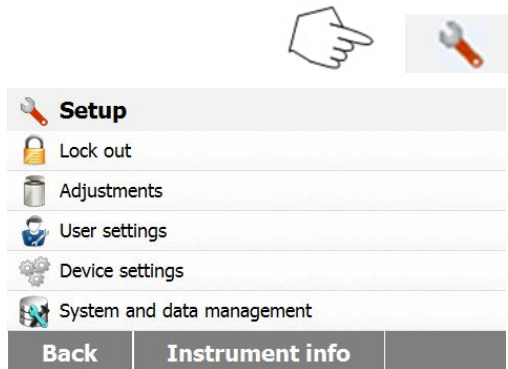

Press Setup button to access the Setup menu.
Press **Back** to return to Home screen.

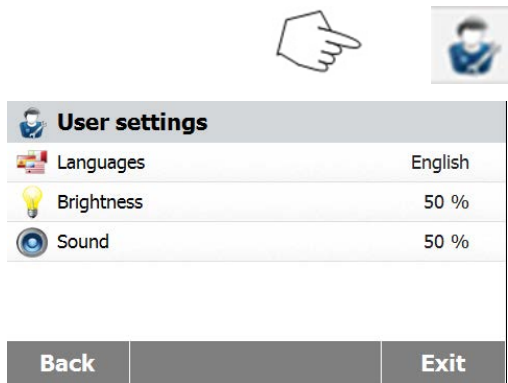

Press **User settings** button to access the User settings menu.
Press **Back** to return to previous screen.
Press **Exit** to return to Home screen.

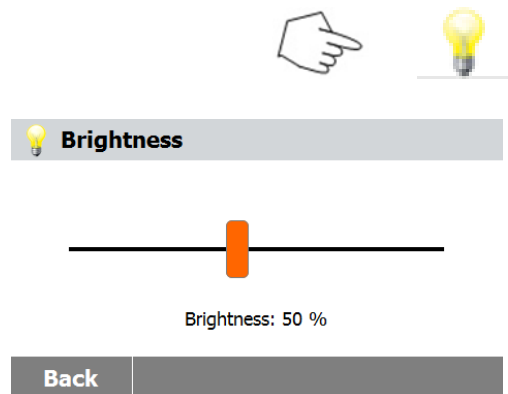

Press Brightness button.

Adjust the brightness of the screen to desired level.

6.3.3 Sound

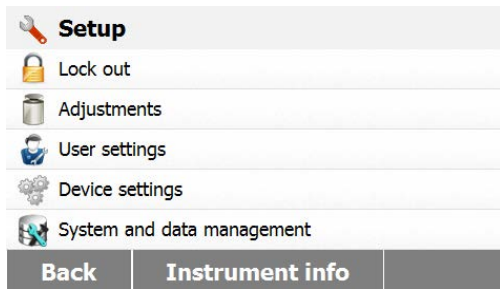

Press Setup button to access the Setup menu.
Press **Back** to return to previous screen.



Press User settings button to access the User settings menu.

Press **Back** to return to previous screen.
Press **Exit** to return to Home screen.

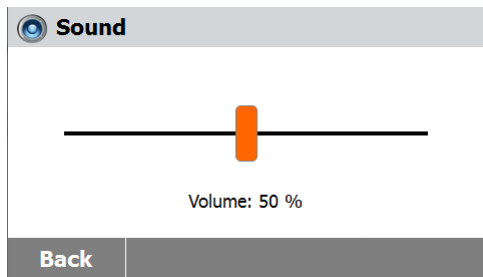

Press Sound button.

Adjust the volume of the beep to desired level.

6.4 Device settings

6.4.1 Date and Time

This Moisture analyzer has a communication output which allows printing the date and time on every record. When this instrument is put into operation for the first time, you should enter the current date and time. These settings are retained even if you disconnect your instrument from the power supply. A built-in battery will maintain all data. To set the date and time, proceed as follows:



Press Setup button to access the setup menu.

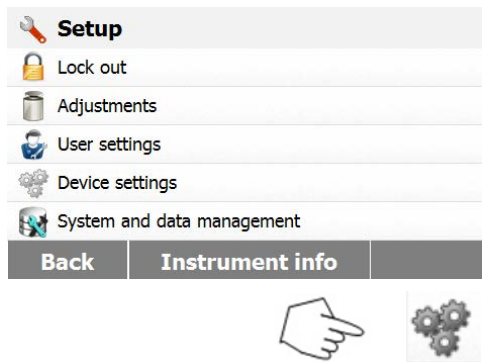

Press **Back** to return to previous screen.

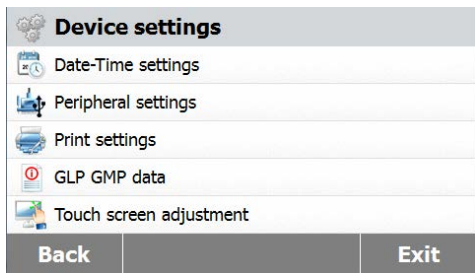

Press Device settings to access the Device settings menu.

Press **Back** to return to previous screen.
Press **Exit** to return to Home screen.

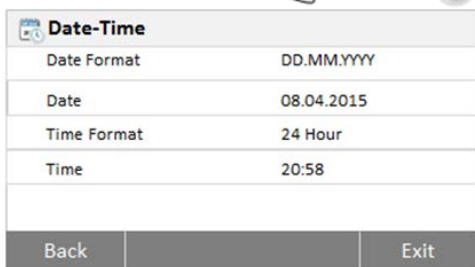

Press the Date-Time button.

Press the follow items to set the date and time.

Press **Back** to return to previous screen.

Press **Exit** to return to Home screen.

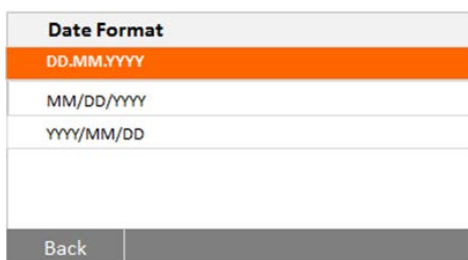

Set date format.

Press **Back** to return to previous screen.

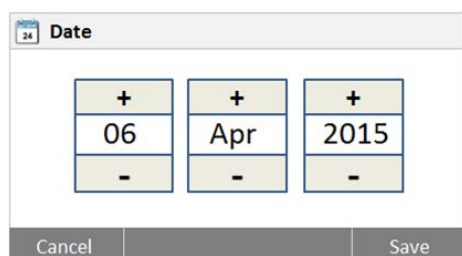

Set date.

Press + and – to set correct date, month and year.

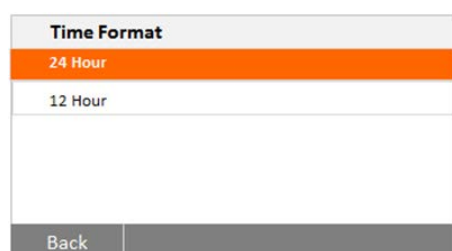

Set time format.

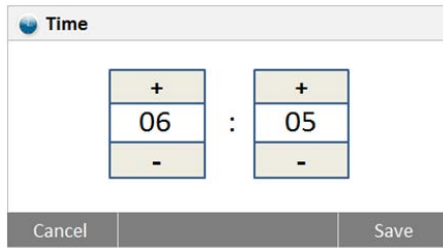

Set time.
Press + and - to set correct time.

6.4.2 Peripherals

This Moisture Analyzer is equipped with USB and RS232 compatible interfaces for communication with USB storage devices, printers and computers. The following sections describe the hardware and software provided with the Moisture Analyzer.

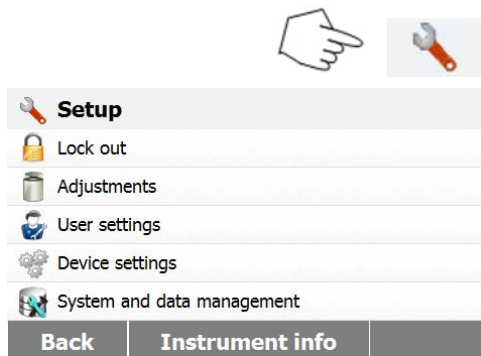

Press Setup button to access the Setup menu.
Press **Back** to return to Home screen.

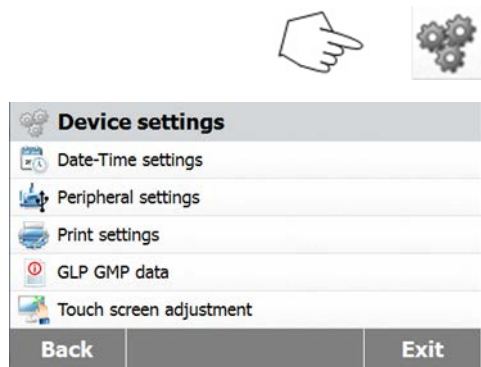

Press Device settings button to access the Device settings menu.

Press **Back** to return to previous screen.
Press **Exit** to return to Home screen.

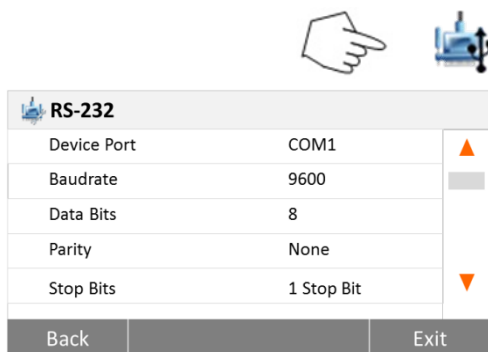

Press Peripherals button.

Select the following items to set RS232 port when RS232 port link to printer or other RS232 compatible device.
Press **Back** to return to previous screen.
Press **Exit** to return to Home screen.

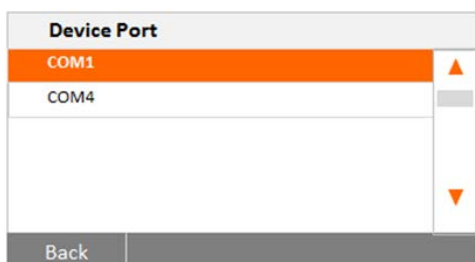

Setting Device port

Select the com1 for RS232, com4 for USB

Baudrate	
1200	▲
2400	■
4800	
9600	
19200	▼
Back	

Setting Baud rate

Select the desired baud rates of 1200, 2400, 4800, 9600, 19200, 38400, 57600 and 115200. Default setting is 9600 Baud.

Data Bits	
7	
8	
Back	

Setting Data bits

Select the desired data bits of 7 or 8. Default setting is 8.

Parity	
None	
Odd	
Even	
Back	

Setting Parity

Select the desired parity setting of either NONE, EVEN or ODD. Default setting is NONE.

Stop Bits	
1 Stop Bit	
2 Stop Bits	
Back	

Setting Stop bits

Select the desired stop bits of 1 or 2. Default setting is 1.

Handshake	
None	
Xon/Xoff	
Back	

Setting Handshake

Select the desired handshake of NONE, Xon/Xoff. Default setting is NONE.

6.4.3 Print



Setup
Lock out
Adjustments
User settings
Device settings
System and data management
Back Instrument info

Press Setup button to access the Setup menu.

Press **Back** to return to Home screen.

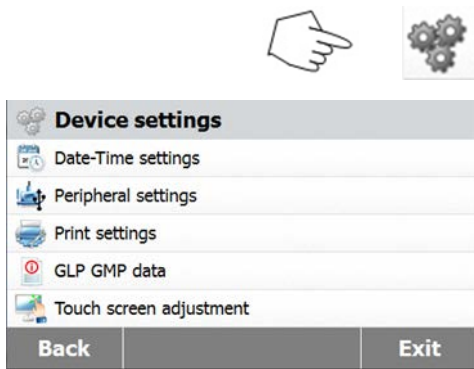

Press Device settings button.

Press **Back** to return to previous screen.
Press **Exit** to return to Home screen.

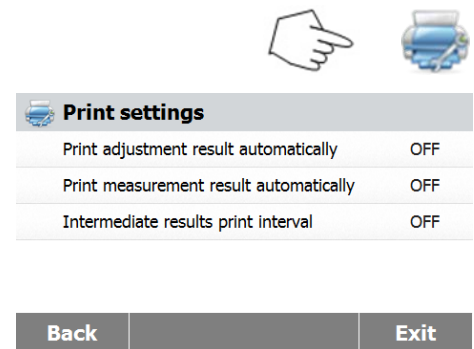

Press Print settings button to access the Print settings menu.
Press **Print adjustment result automatically** to switch ON or OFF.
Press **Print measurement result automatically** to switch ON or OFF.
Press **Intermediate results print interval** to set the print interval.
Press **Back** to return to previous screen.
Press **Exit** to return to Home screen.

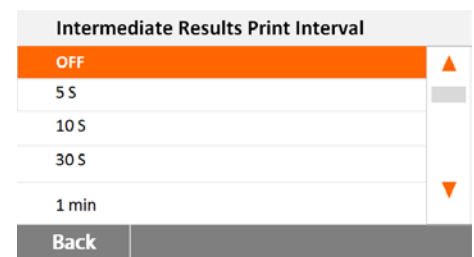

Press the Intermediate results print interval button.
Choose the interval seconds or minutes.

6.4.4 GLP and GMP Data

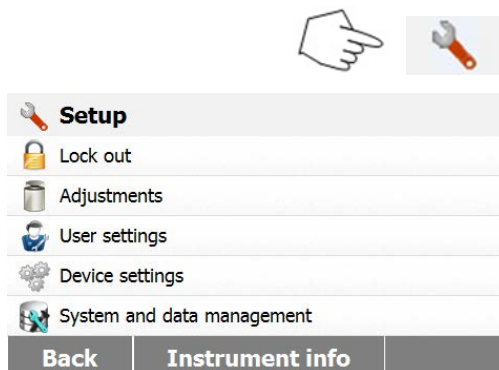

Press Setup button to access the setup menu.
Press **Back** to return to Home screen.

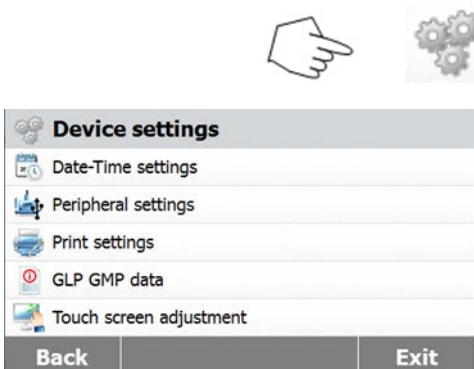

Press Device settings button to access the Device menu settings.

Press **Back** to return to previous screen.
Press **Exit** to return to Home screen.



GLP and GMP Data	
Company Name	<i>not defined</i>
Department	<i>not defined</i>
Instrument ID	<i>not defined</i>
<div style="display: flex; justify-content: space-between; padding: 5px;"> Back Exit </div>	

Press GLP and GMP Data to access the GLP and GMP Data menu.

Press **Back** to return to previous screen. Press **Exit** to return to Home screen.

Press Company name, Department or Instrument ID buttons to define related information.

6.4.5 Touch Screen Adjustment



Setup	
Lock out	
Adjustments	
User settings	
Device settings	
System and data management	
<div style="display: flex; justify-content: space-between; padding: 5px;"> Back Instrument info </div>	

Press Setup button to access Setup menu.

Press **Back** to return to Home screen.



Device settings	
Date-Time settings	
Peripheral settings	
Print settings	
GLP GMP data	
Touch screen adjustment	
<div style="display: flex; justify-content: space-between; padding: 5px;"> Back Exit </div>	

Press **Device settings** to access the device settings.

Device Settings	
<div style="border: 1px solid gray; padding: 5px;"> <p>Touch screen adjustment</p> <p>Tap and hold the center of the target with a stylus. Tap the screen to accept the settings as target stops moving (or they will be discarded after 30 sec)</p> <div style="display: flex; justify-content: space-around; padding: 5px;"> Cancel Start </div> </div>	
<div style="display: flex; justify-content: space-between; padding: 5px;"> Back Exit </div>	

Press **Touch screen adjustment** to adjust the touch screen.

Press the **Start** button to start the adjustment.

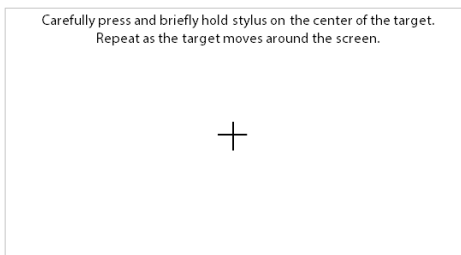

Please follow the process to adjust the screen.

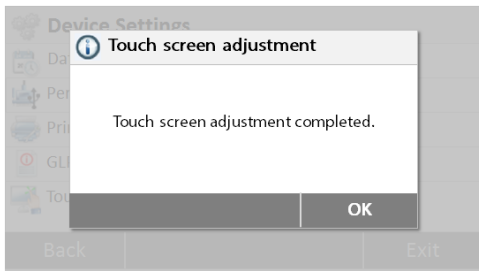

When the adjustment complete, press **OK** to exit.

6.5 System and data management

6.5.1 Export and import settings and methods

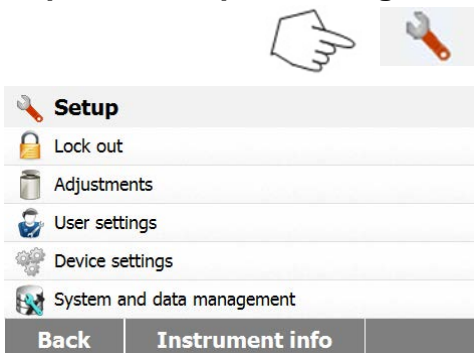

Press Setup button to access Setup menu.
Press **Back** to return to Home screen.

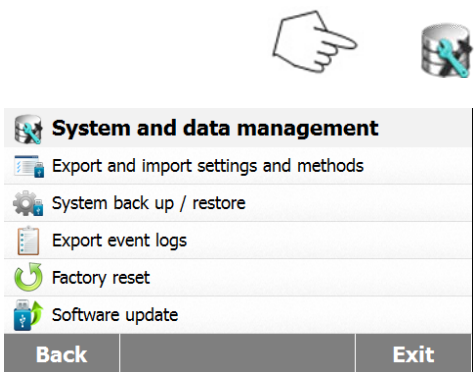

Press System and data management button to access the System and data management menu.

Press **Back** to return to previous step.
Press **Exit** to return to Home screen.



Press **Export and import settings and methods** to access the export and import menu.

6.5.1.1 Export data

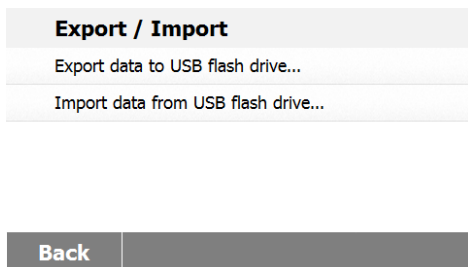

Press **Export data to USB flash drive** to select location and export data to USB drive.

Press **Back** to previous step.
Press **Exit** to return to Home screen.

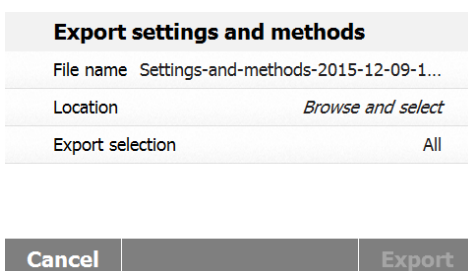

Press **File name** to change file name.
Press **Location** to select the export location.
Press **Export selection** to select the export items.

Press **Cancel** to previous step.

Export selection	
<input checked="" type="checkbox"/>	User settings
<input checked="" type="checkbox"/>	Methods (2)

Press the items to select.
 Press **Cancel** to cancel data export.
 Press **OK** to confirm and back to previous step.

Cancel	OK
---------------	-----------

Export settings and methods	
File name	Settings-and-methods-2015-12-09-1...
Location	C:/IDE
Export selection	All

Cancel	Export
---------------	---------------

After selecting the location, **Export** button is available.
 Press **Cancel** to cancel data export.
 Press **Export** to execute.

6.5.1.2 Import data

Export / Import	
<input type="checkbox"/>	Export data to USB flash drive...
<input type="checkbox"/>	Import data from USB flash drive...

Back

Press **Import data from USB flash drive** to select location and import data from USB drive.
 Press **Back** to previous step.

Import settings and methods	
Import from file	<i>Browse and select</i>

Press **Import from file** to select the file to import.
 Press **Cancel** to cancel data import.

Cancel	Import
---------------	---------------

Import settings and methods	
Import from file	Settings-and-methods-2015-12...
Location	E:/
Import selection	All (1)

After select the import file, the **Import** button is available.
 Press **Cancel** to cancel data import.
 Press **Import** to execute.

Cancel	Import
---------------	---------------

6.5.2 Backup and restore



Press **Backup and restore** to backup or restore the system settings.

6.5.2.1 Backup system

Back up / Restore	
Back up system on USB flash drive...	
Restore system from selected back up...	
Back	

Press **Backup system on USB flash drive** to back up system.

Press **Back** to previous step.

Press **Back** to return to previous step.

Back up	
File name	Backup-2015-12-09-20-45
Location	<i>Browse and select</i>

Press **File name** to change file name.

Press **Location** to select backup location.

Press **Cancel** to cancel backup.

Cancel		Backup
---------------	--	---------------

After select backup location, the **Backup** button is available

Press **Cancel** to cancel the backup.

Press **Backup** to execute.

Back up	
File name	Backup-2015-12-09-20-53
Location	C:/IDE

Cancel		Backup
---------------	--	---------------

6.5.2.2 Restore system

Back up / Restore	
Back up system on USB flash drive...	
Restore system from selected back up...	
Back	

Press **Restore system** from selected back up to restore system.

Press **Back** to previous step.

Restore	
Restore from file	<i>Browse and select</i>

Press **Restore from file** to select the restore file.

Press **Cancel** to cancel the restore.

Cancel		Restore
---------------	--	----------------

Restore	
Restore from file	Backup-2015-12-09-21-05
Location	E:/Backup-2015-12-09-21-05
<div style="display: flex; justify-content: space-between; width: 100%;"> Cancel Restore </div>	

After select the restore file, the **Restore** button is available.

Press **Cancel** the restore.
Press **Restore** to execute.

6.5.3 Export event logs



Export event logs	
File name	Events-2015-12-09-17-54
Location	<i>Browse and select</i>
<div style="display: flex; justify-content: space-between; width: 100%;"> Cancel Export </div>	

Press **Export event logs** to access the export event logs menu.

Press **File name** to change file name.
Press **Location** to select the export location.
Press **Cancel** back to previous step.

Export event logs	
File name	Events-2015-12-09-17-54
Location	C:/IDE
<div style="display: flex; justify-content: space-between; width: 100%;"> Cancel Export </div>	

After select the export location, the Export button is available.

Press **Cancel** to cancel export.
Press **Export** to execute.

6.5.4 Factory reset



Reset	
Factory reset will revert all the changes to factory settings.	
<div style="display: flex; justify-content: space-between; width: 100%;"> Cancel Reset </div>	

Press Factory reset button to reset to factory default settings.

Press **Cancel** to return to previous screen without resetting.
Press **Reset** to perform a reset.

CAUTION:
All methods and test results will be deleted when performing a factory reset.

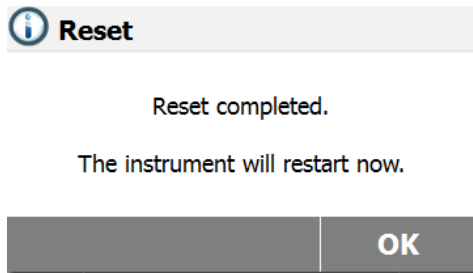

After factory reset, press **OK** to restart instrument.

6.5.5 Software update

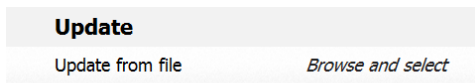

Press **Software update** to access the update the software.

Press **update from file** to select file to update.

Press **Cancel** to return to previous screen.

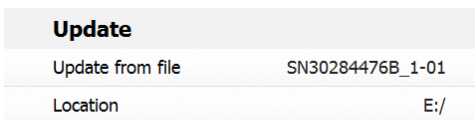

After select the update file, the **Update** button is available.

Press **Update** to execute.



7. METHOD LIBRARY

This section contains information on the use of the Method Library which will enable you to set the actual drying parameters such as Profile, Switch-Off, Display, Target Weight and the use of the library.

The Operating Concept

You have already set the Moisture Analyzer setup in Section 6 and have tried the simple moisture determination in Section 4. You are now ready to perform moisture determinations in a precise manner. The test menu shown in Section 7 offers a number of setting possibilities to match the measurement process to your specific requirements. For instance, you can select the drying temperature, type of display and many other parameters. Please keep in mind the importance of preparing your sample, the distribution of the sample on the weighing pan, the type of sample and the temperature range. Remember, the greater the number of uniform samples tested, the greater the accuracy of the results. Please review this entire section before actually making any settings to become familiar with the instrument.

7.1 Method load, edit and delete.

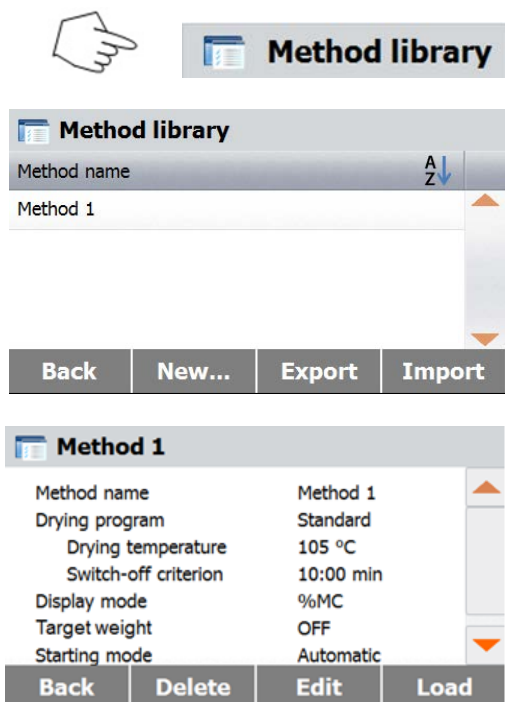

Press Method library in Home screen.

Press method name to check method settings and load to current method.

Press **Back** to Home screen.

Press **New** to create a new method.

Press **Export** to export methods.

Press **Import** to import methods.

Enter the **Method 1** to check the settings.

Press **Back** to previous screen.

Press **Delete** to delete this method.

Press **Edit** to edit method settings.

Press **Load** to load this method as current method.

7.2 Entering Method Name

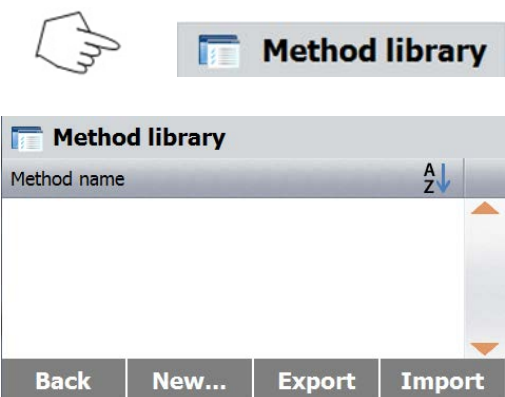

Press Method Library on the Home screen. The method library is displayed.

Complete information on how to use the library is covered in this section.

Press **New** button to start a new test.

The screen will change to key in the new method name.

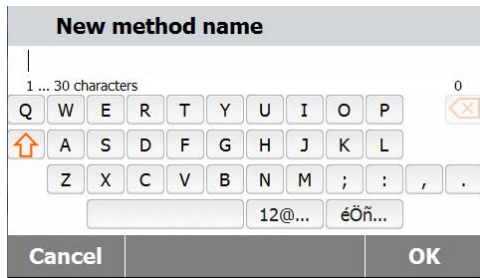

Enter either a method name or identifying number and press the OK button.

7.3 Setting the Drying Profile

The drying profile contains two settings, Standard and Fast. This section describes each of the drying profiles. Review the profile descriptions. Depending upon the sample material to be analyzed, select the appropriate profile and proceed as follows:

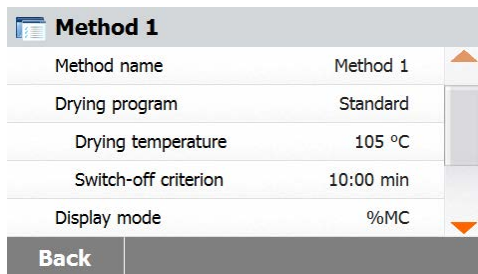

Press the Drying profile button.
Standard Profile

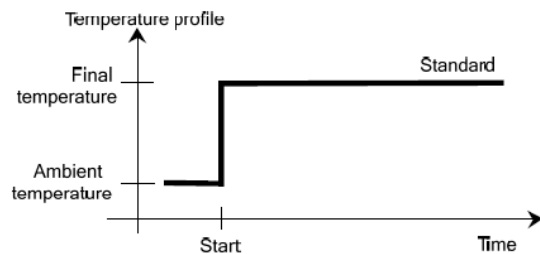

Fast Profile

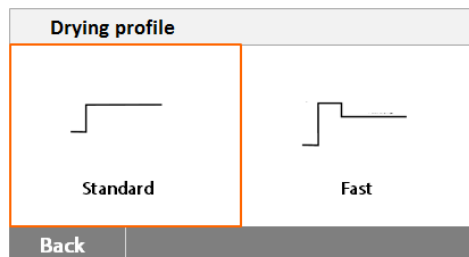
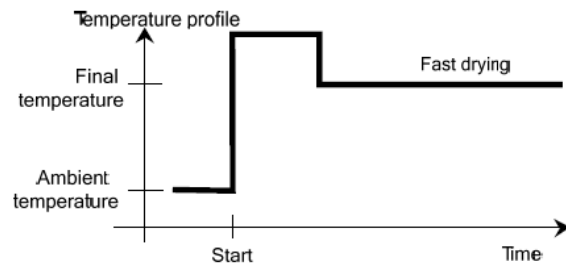

7.4 Setting the Drying Temperature

The drying temperature can be set from 40 °C to 200 °C.

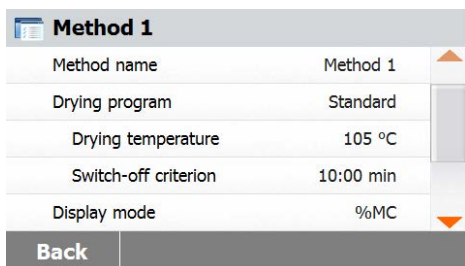

Press the Drying Temperature button to access the temperature setting menu.

Enter the desired drying temperature and press the OK button.

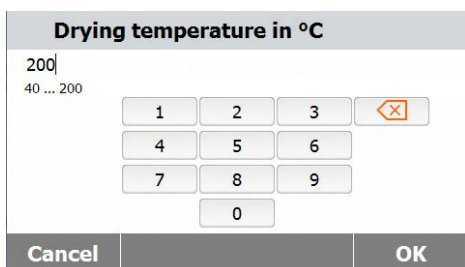

7.5 Selecting the switch-off criterion

This menu offers you different switch-off criterion. Switch-off criterion defines when the instrument should end the drying. Switch-off criterion eliminates checking your watch or clock and stopping the drying manually. Review the list below and select one criterion that suits your purpose.



The following settings can be selected for the switch-off criterion:

- Timed switch-off
- Auto switch-off

Timed switch-off

With this switch-off criterion selected, the measurement lasts until the preset drying time has elapsed (the display provides you with continuous information on the drying time).

Using the +/- buttons, enter the desired drying time and press the OK button.

Auto switch-off

The switch-off criterion is based on a **weight loss per unit of time**. As soon as the mean weight loss is less than a preset value during a specified time, the instrument considers drying as complete and automatically discontinues the measurement process. During drying, the display indicates the elapsed time of the drying process; the switch-off criterion is inactive during the first 30 seconds.

The automatic switch-off criterion is less than 1mg loss in 60 seconds.

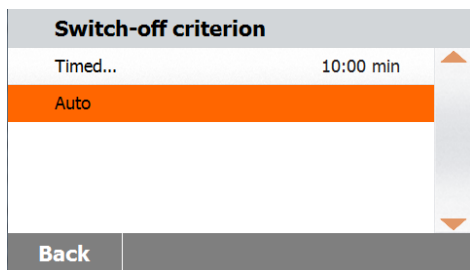

7.6 Displayed result

Displayed result offers you the choice of whether your display indicates % MC, % DC, % RG or grams during the measurement process.

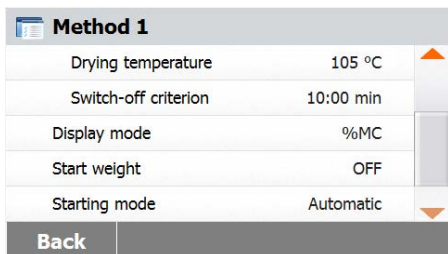

Press the Displayed result button.

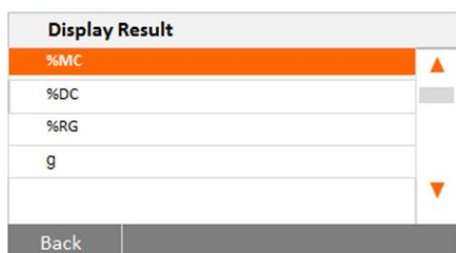

Select %MC, %DC, %RG or g.

$$\%MC(\text{Moisture Content}) = \frac{\text{Initial weight} - \text{Final weight}}{\text{Initial weight}} \times 100\%$$

$$\%DC(\text{Solids Content}) = \frac{\text{Final weight}}{\text{Initial weight}} \times 100\%$$

$$\%RG(\text{Regain Content}) = \frac{\text{Initial weight} - \text{Final weight}}{\text{Final weight}} \times 100\%$$

7.7 Target Weight

Target weight is used when previous samples have been tested and the target weight is known. A consistent sample size is required when using Target Weight. If the target weight is out of tolerance, the measurement cannot be started.

Method 1	
Drying temperature	105 °C
Switch-off criterion	10:00 min
Display mode	%MC
Target weight	OFF
Starting mode	Automatic
Back	

Select the Target Weight.

Target weight in g	
0.500 ... 90.000	
1	2
4	5
7	8
.	0
Back ON OK	

Enable the Target weight and press ON button.

Target weight in g	
3.000	
0.500 ... 90.000	
1	2
4	5
7	8
.	0
Cancel OFF OK	

Set the target weight and press OK button.

Method 1	
Drying temperature	105 °C
Switch-off criterion	10:00 min
Display mode	%MC
Target weight	3.000 g
Target weight tolerance	10 %
Cancel Save	

Press **Target weight tolerance** to set the tolerance of target weight.

Target weight tolerance in %	
10	
1 ... 25	
1	2
4	5
7	8
0	
Back OK	

Set the target weight tolerance in %.

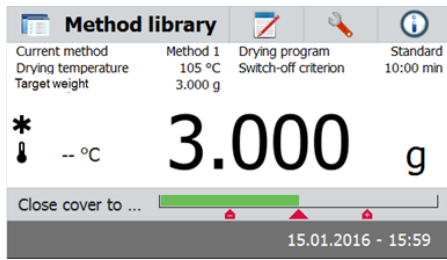

The check weighing bar indicates the sample weight.

7.8 Starting Mode

In this menu you can define if the instrument should perform certain functions automatically or manually.

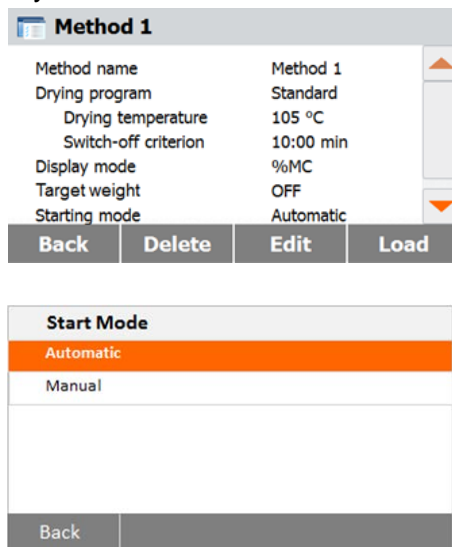

Press the Starting mode button.

Automatic

This mode can be used for most kinds of samples. When closing the sample chamber, the weight of the sample is recorded and the measurement is started. It is the factory default setting.

Manual

We advise you to use the manual operating mode for samples which contain readily volatile substances. In contrast to the automatic operating mode, in the manual operating mode the sample chamber does not automatically close when the Start/Stop button is tapped. However, the initial weight important for the determination of the moisture content is recorded. In the manual operating mode you have time for further preparation of the sample while weight losses due to evaporation during the preparation time are measured from the outset. As soon as the sample is ready for drying, close the sample chamber. As soon as the automatic sample chamber is closed, drying starts. In the manual operating mode you can open the sample chamber during a drying operation. In contrast to the automatic mode, drying will not be stopped but simply interrupted until the automatic sample chamber is closed again.

7.9 Default method

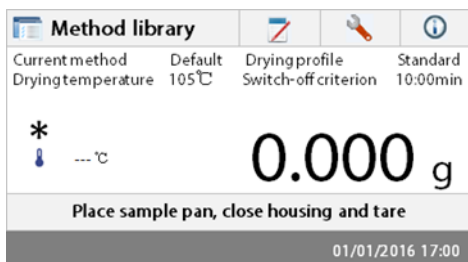

The analyzer comes with a default method preinstalled. Follow the instruction message to start a measurement directly. Press parameters area to edit.

Default	
Method name	Default
Drying program	Standard
Drying temperature	105 °C
Switch-off criterion	10:00 min
Display mode	%MC

Back

Default	
Method name	Default
Drying program	Standard
Drying temperature	120 °C
Switch-off criterion	10:00 min
Display mode	%MC

Cancel **Save**

After change the settings, the **Save** button available.
 Press **Save** to save to default method.

7.10 Method export and import.

Method library

Method library	
Method name	A Z ↓
Method 1	

Back **New...** **Export** **Import**

Press Export to export methods.

Export methods	
File name	Methods-2015-12-20-20-13
Location	<i>Browse and select</i>
Export selection	All (2)

Press **File name** to change export file name.
 Press **Location** to select the export location.
 Press **Export selection** to select methods to export.

Cancel **Export**

Press **Cancel** to previous screen.

Export methods	
File name	Methods-2015-12-20-20-13
Location	C:/
Export selection	All (2)

After select the export location and methods, the **Export** button is available.
 Press **Export** to execute.

Cancel **Export**

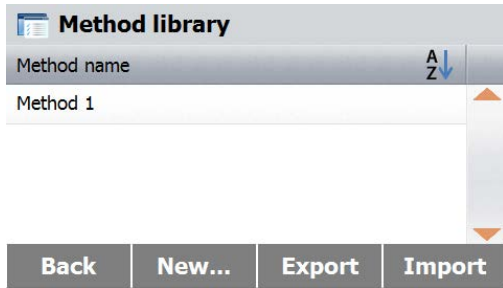

Press **Import** to import methods.

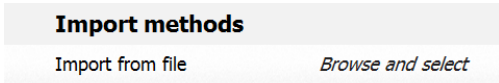

Press **Import from file** to select the file to import.

Press **Cancel** to previous screen.



After select the import file, the **Import** button is available.

Press **Location** to change the import location.
Press **Import selection** to select methods to import.

Press **Cancel** to previous screen.



8. RESULTS

This section contains the management and evaluation of measurement results.

8.1 Test Results



Press Results button on the Home screen to access the results menu.

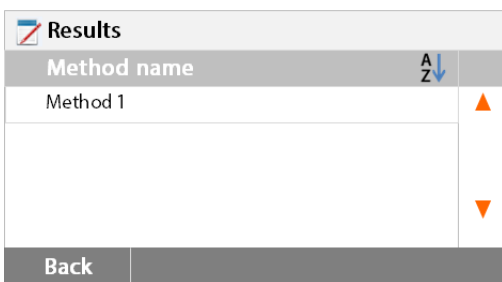

Select the method name to list all the test results of the method.

Press **Back** to return to Home screen.

8.1.1 Result data and curve



Press result item to access the detail data.
Press **Back** to previous step.

Press **Delete** to delete the results.

Press **Export** to export these results.

Press **Statistics** to access statistics menu.

Method 1

UserName	Administrator
Initial weight	3.500 g
Elapsed time	10:00 min
Final weight	3.150 g
Final result	10.00 %MC
10.12.2015 - 14:27	

Back Delete Export Curve

Press **Back** to previous step.
 Press **Delete** to delete current result.
 Press **Export** to export current result.
 Press **Curve** to show result curve.

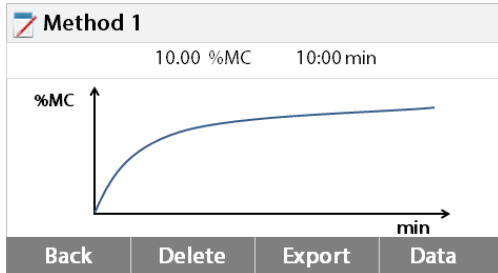

Press **Back** to results list.
 Press **Delete** to delete current result.
 Press **Export** to export current result.
 Press **Data** to show detailed result data.

8.1.2 Statistics

Method 1

10.12.2015 - 14:27	10.00 %MC
10.12.2015 - 14:00	10.06 %MC

Back Delete Export Statistics

Select the method name to list all the test results of the method.
 Press **Statistics** to access statistics menu.

Result selection

Custom selection of "All" (0)

<input type="checkbox"/>	10.12.2015 - 14:27 10.00 %MC
<input type="checkbox"/>	10.12.2015 - 14:00 10.06 %MC

Cancel OK

Press result item to select.

Press  to select all items.

Press **Cancel** back to previous step.

Result selection

"All" (2)

<input checked="" type="checkbox"/>	10.12.2015 - 14:27 10.00 %MC
<input checked="" type="checkbox"/>	10.12.2015 - 14:00 10.06 %MC

Cancel OK

After select the items, the OK button is available.

Press result item to remove.

Press  to remove all items.

Press **Cancel** back to previous step.

Press **OK** to execute.

Statistics

Sample number	2
Last data	10.00 %MC
Mean X	10.03 %MC
Standard deviation	0.04%
Min X	10.00 %MC
Max X	10.06 %MC

Back

8.1.3 Result export

Method 1		
10.12.2015- 14:27	10.00 %MC	▲
10.12.2015- 14:00	10.06 %MC	
▼		

Back Delete Export Statistics

Press **Export** to export all the results.

Export results	
File name prefix	Method 1
Location	<i>Browse and select</i>
Export selection	" All" (2)

Cancel Export

Press **File name prefix** to edit file name.
 Press **Location** to select export location.
 Press **Export selection** to select export results.
 Press **Cancel** to previous step.

Export results	
File name prefix	Method 1
Location	<i>Browse and select</i>
Export selection	" All" (2)

Cancel Export

After select the export location, the **Export** button is available.
 Press **Cancel** to previous step.
 Press **Export** to export results.

Method 1		
10.12.2015- 14:27	10.00 %MC	▲
10.12.2015- 14:00	10.06 %MC	
▼		

Back Delete Export Statistics

Press result item to check one result data and export it.

Method 1		
User Name	Administrator	▲
Initial weight	3.500 g	
Elapsed time	10:00 min	
Final weight	3.150 g	
Final result	10.00 %MC	
10.12.2015- 14:27		▼

Back Delete Export Curve

Press **Export** to export this result.

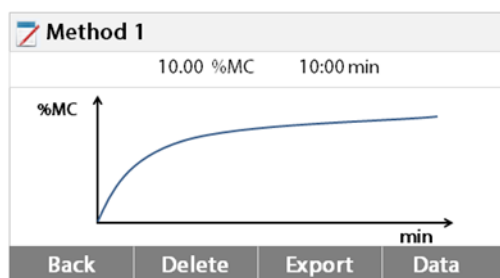

Press **Export** to export this result.

Export results	
File name	Method 1-2015-12-10-15-40
Location	<i>Browse and select</i>
Cancel	Export

Press **File name** to edit file name.
 Press **Location** to select export location.
 Press **Cancel** to previous step.

Export results	
File name	Method 1-2015-12-10-15-40
Location	<i>Browse and select</i>
Cancel	Export

After select the export location, the Export button is available.
 Press **Cancel** to previous step.
 Press **Export** to the export result.

9. HELP INFORMATION

Level Assist

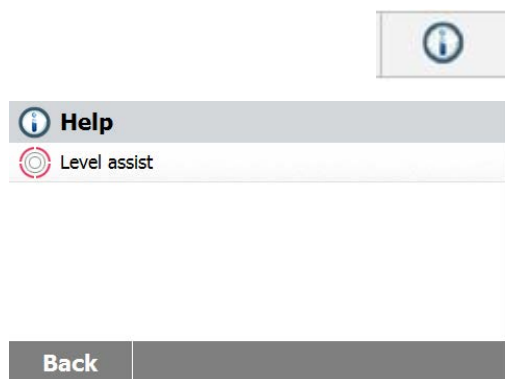

Press Help button on the Home screen to access the help information menu.

Select Level Assist button to access it.
 Please adjust the level feet accordingly.

Press screen to exit.

10. PRINTING TEST DATA

Printing data to an external computer or printer requires the communication parameters be set first.

Printing to an external printer or computer will occur each time the Print button is pressed. If the Print Interval is set in the Test Menu, printing can occur in a continuous fashion at specified intervals.

Samples of weight adjustment, temperature adjustment and test data (GLP on and GLP off) are shown as follows:

Weight adjustment printout

```

WEIGHT ADJUST EXTERNAL

1.Jan 2016  11:20

Halogen Moisture Analyzer

Type           MB90
SNR(Drying Unit) 1234567
SNR(Terminal)

Weight ID
Nominal Weight          50.000 g
Actual Weight          50.000 g
Difference              0.000 g
Cell Temperature      24.35 °C

Adjustment          Done

Signature:

.....
-----END-----

```

Temperature adjustment printout

```

TEMPERATURE ADJUSTMENT

1.Jan.2016  11:25

Halogen Moisture Analyzer

Type           MB90
SNR(Drying Unit) 1234567
SNR(Terminal)

Temp Kit ID
Temp1 target    100 °C
Temp1 actual    99 °C
Temp2 target    160 °C
Temp2 actual    161 °C

Adjustment      Done

Signature:

.....
-----END-----

```

Test data printout

Interval at 30 seconds.

```

MOISTURE DETERMINATION

Halogen Moisture Analyzer
Type           MB90
SNR(Drying Unit) 1234567
SNR(Terminal)
SW(Drying Unit)  1.20
SW(Terminal)     1.01.01

Method Name     Method 1
Drying Prog     Standard
Drying Temp     105°C
Switch Off      A60(1mg/60s)

Start Weight    3.098 g
00:00 min      0.00%MC

```

Statistics printout

```

--- STATISTICS DATA ---

Halogen Moisture Analyzer
Type           MB90
SNR(Drying Unit) 1234567
SNR(Terminal)
SW(Drying Unit)  1.20
SW(Terminal)     1.01.01

Sample Number   6
Last Data       86.23 %MC
Mean Value      87.01 %MC
Standard Deviation 2.06
Minimum Value   83.47 %MC
Maximum Value   88.98 %MC

```

```

00:30 min    9.17 %MC
01:00 min    12.35 %MC
01:30 min    15.28 %MC
02:00 min    21.94 %MC

05:00 min    29:36 %MC
05:21 min    31.94 %MC
Total Time.   05:21 min
End Result   . 31.94 %MC
Sample ID:

.....

Signature:

.....

      1.Jan.15  15:35

-----END-----
    
```

```

Signature:

.....

-----END-----
    
```

Attention: When printing data to an OHAUS SF40A printer, please disable the printer setting "Balance Feature" first.

10.1 RS232 Command Table

Output Formats

Data output can be initiated in one of two ways:

1. By pressing the Print button;
2. Using the Print Interval feature;

RS232 Commands

All communication is accomplished using standard ASCII format. Only the characters shown in the following table are acknowledged by the Moisture Analyzer. Invalid command response "ES" error indicates the Moisture Analyzer has not recognized the command. Commands sent to the Moisture Analyzer must be terminated with a Line Feed or carriage return-line line feed (CRLF). Data output by the Moisture Analyzer is always terminated with a carriage return-line feed (CRLF).

RS232 COMMAND TABLE

Command Character	Description
V	Print SR Version
TIM	Print Current Time
DAT	Print Current Date

10.2 RS232 Pin out

The following table illustrates the pin-out connections on the RS232 connector.

1		N/C
2	<-	Date Out (TXD)
3	->	Date Out (RXD)
4&6		N/C
5		Ground
7	->	Clear to send (CTS)
8	<-	Request to send (RTS)
9		N/C

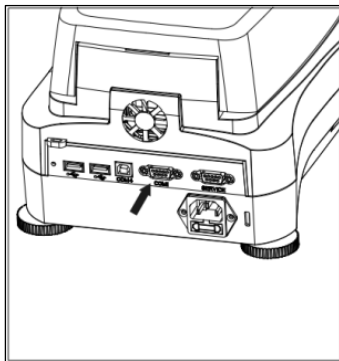

Attention: The RS232 port (COM 1) is located near the USB device port.

11. CARE AND MAINTENANCE

In this section, you will learn how to keep your Moisture Analyzer in good condition and how to replace consumable parts.

11.1 Cleaning Interior/Exterior Components

To continue to obtain precise measurements, it is advisable to clean the interior components at regular intervals. Please note the following instructions for cleaning your instrument.

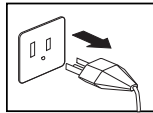

WARNING: Electric Shock Hazard. Disconnect the equipment from the power supply before cleaning.

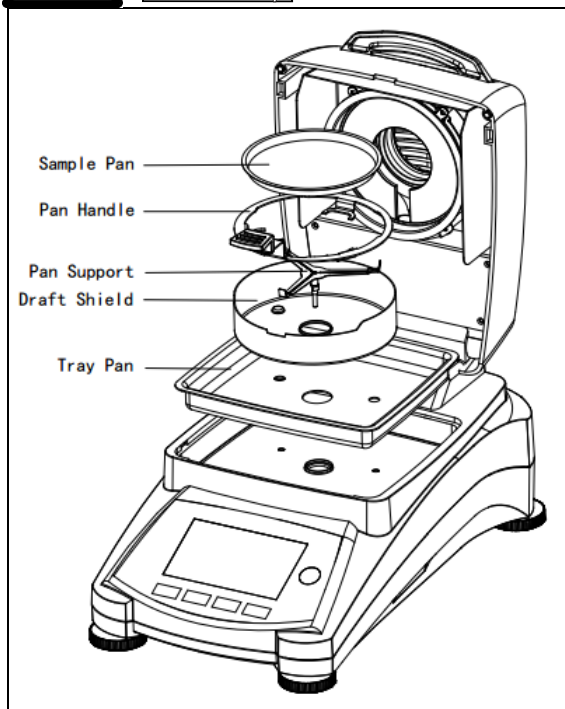

Open the cover and remove the pan handle, sample pan, draft shield, and heat shield from the instrument before cleaning.

Use a lint-free cloth for cleaning.

Clean the exterior of the instrument and the drying compartment components with a mild cleaning agent. Although the housing is extremely rugged and resistant to solvents, never use abrasive cleaning agents or solvents!

Ensure that no liquid enters the interior of the instrument.

Replace the components after cleaning.

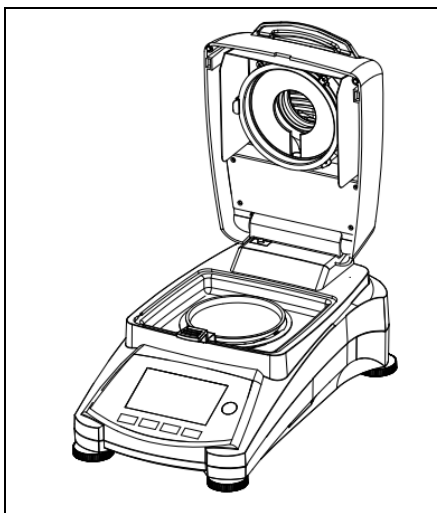

Cleaning Temperature Sensor and Protective Glass

Check the protective glass and the temperature sensor for debris which could impede the operation. If the glass appears dirty, clean the surface facing the compartment using a commercial glass cleaner. If the sensor is dirty, clean using a mild cleaning agent.



WARNING: Do not spray the glass cleaner directly on the glass. Instead, spray it on a cloth and use the cloth to clean.

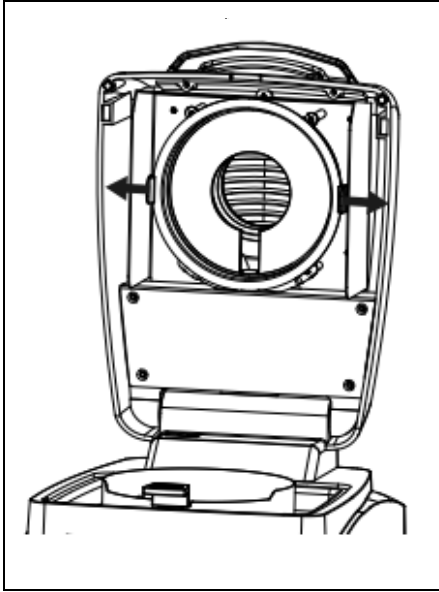

Removing Glass for Cleaning

If the inside of the glass is dirty, lift up the heating chamber, release the glass for cleaning by pressing both sides of the glass holder.

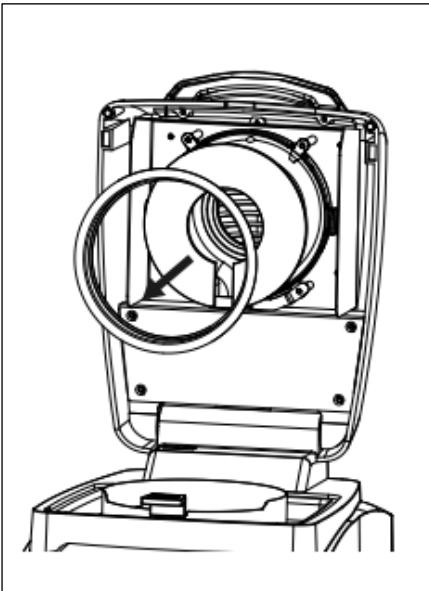

Attention: Caution when releasing the glass from the glass holder.

Reassemble after cleaning.



WARNING: Do not touch or clean the Halogen heater.

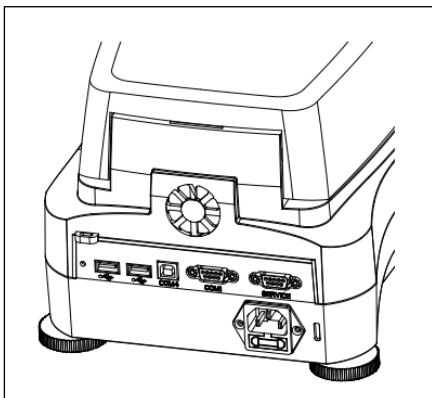

Cleaning air inlet

The air inlet of the fan is located at the rear of the instrument and its exterior should be cleaned from time to time to free it from any dust deposits.

11.2 Replacing Power Line Fuse

If the instrument display fails to light after switching it on, check the power outlet first. If power is available, and the instrument fails to operate, the power fuse may be open (blown).

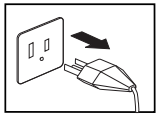
 	<p>WARNING: Electric Shock Hazard. Disconnect the equipment from the power supply before cleaning.</p>
---------------------------------------------------------------------------------------------------------------------------------------------------------------------	---------------------------------------------------------------------------------------------------------------

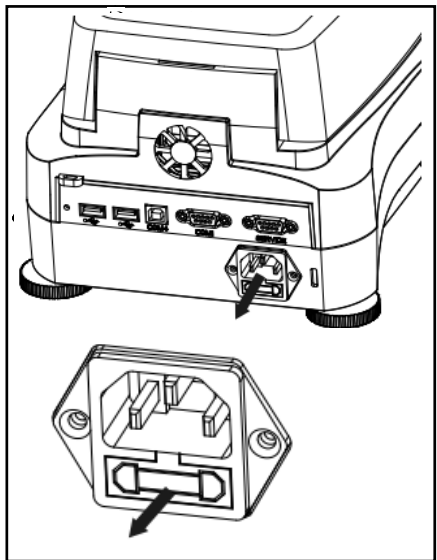

Using a test pen, turn the fuse holder to the left (counterclockwise) and remove the fuse.

Check the condition of the fuse. Replace blown fuse by those of the same type with the same rated value (6.3A 250VAC for 100-120VAC power supply or 2.5A 250VAC for 200-240VAC power supply according to the heating element).

Attention: If the fuse is good and power is available at the outlet, the cord or instrument may be defective. Try a new cord. If this does not work, the instrument should be sent back for servicing.



The use of a fuse of a different type or with a different value, or bridging or shunting the fuse is not allowed and can possibly cause a hazard to your safety and lead to instrument damage!

11.3 Troubleshooting

Problem: Under load

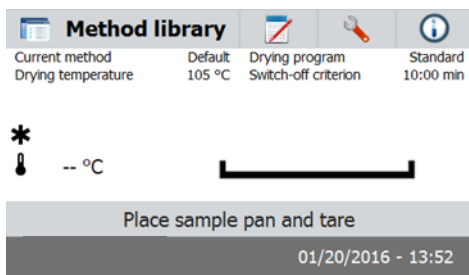

Probable cause:
-No pan support. Put the pan support on the correct position.

Problem: Over load

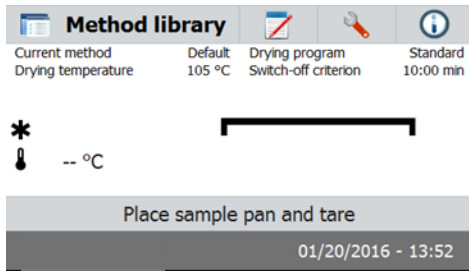

Probable causes:
-Put too many sample. Try to remove the sample from the sample pan.

Problem: Display remains dark after switching ON.

Probable causes:

- No line voltage
- Power cable not connected
- Power line fuse blown
- Instrument faulty

Problem: The measurement takes too long.

Probable cause: — You have selected an unsuitable switch-off criterion. Try experimentation to arrive at a suitable switch-off criterion.

Problem: The instrument does not heat following the start up.

Probable cause: — The dryer is overheated and the thermal overload protection has responded. For safe operation, the instrument is equipped with a duplicate overheating protection device: The dryer unit has a thermal overload protection device which switches off the heating element. Contact your OHAUS dealer.

Problem: The measurements are not repeatable.

Probable causes:

- The samples are not homogeneous, i.e. they have different compositions. The more inhomogeneous a sample, the larger the amount of sample needed to obtain a repeatable result.
- You have selected a drying time that is too short. Extend the drying time or select a suitable switch-off criterion "Weight loss per unit of time".
- The sample does not come completely dry (e.g. owing to skin formation). Dry the sample on quartz sand.
- You have selected a temperature that is too high and the sample has oxidized. Lower the drying temperature.
- The sample boils and the splashed drops continuously change the weight. Lower the drying temperature.
- Insufficient heating power as the protective glass is dirty. Clean the protective glass.
- The temperature sensor is contaminated or faulty. Clean the temperature sensor.
- The support on which the instrument is standing is not stable. Use a stable support.
- The surroundings are very unstable (vibrations etc.).

11.4 Error detection

The Moisture Analyzer utilizes an audio tone to indicate an error. A *normal* button press or entry results in a short, high pitched tone. When an entry is incorrect or an improper button is pressed, a low pitched tone is emitted. There are no system error codes shown on the displays under these conditions.

11.5 Service information

If the Troubleshooting section does not resolve or describe your problem, you will need to contact an authorized Ohaus Service Agent. For Service assistance in the United States, please call Aftermarket, Ohaus Corporation toll-free at (800) 526-0659. An Ohaus Product Service Specialist will be available to help you.

11.6 Accessories

Description	Ohaus Part No.
Reusable Sample Pan	80252478
Security Locking Cable	80850043
Printer SF40A	30045641
Sample Pans 90mm diameter	80850086
Glass Fiber Pads	80850087
In-use Cover	30284478
Temperature Calibration Kit	11113857

12. TECHNICAL DATA

12.1 Admissible ambient conditions

Indoor use only



Altitude:	Up to 4000m
Temperature range:	10 °C to 40 °C
Atmospheric humidity:	Maximum relative humidity 80% for temperatures up to 31 °C decreasing linearly to 50% relative humidity at 40 °C.
Warm-up time:	At least 30 minutes after connecting the instrument to the power supply; when switched on from standby-mode, the instrument is ready for operation immediately.
Voltage fluctuations:	Mains supply voltage fluctuations up to $\pm 10\%$ of the nominal voltage
Over voltage category:	II
Pollution degree:	2
Power load:	Max. 450 W during drying process
Power supply voltage:	100 V – 90 VAC 5A 50/60 Hz or 200 V – 240 VAC 2.5A 50/60 Hz (depending on the model)
Power line fuse:	6.3A 250VAC for 100-120VAC power supply or 2.5A 250VAC for 200-240VAC power supply according to the heating element

12.2 Specifications

Model	MB90
Capacity	90
Readability	0.01%/0.001g
Repeatability (Std Dev) (g)	0.18% (3g sample) 0.02% (10g sample)
Moisture range	0.01% to 100% (0.01% to 1000% for regain mode)
Heating Element	Halogen
Drying Programs	Standard, Fast
Temp range	40° C - 200° C
Switch-off Criteria	Timed, Auto, manual
Adjustment	External adjustment mass - 50g
Power	100 V – 90 VAC 5A 50/60 Hz 200 V – 240 VAC 2.5A 50/60 Hz
Operating temperature range	50° to 104°F / 10° to 40°C
Display type	4.3', QVGA, TFT touch screen
Display results	%moisture, %solids, %regain, time, temperature, weight, method name, drying curve and statistics
Pan size (mm)	90
Interface	RS232, USB host, USB device,
Adjustable Feet and Level	Yes
Dimensions (WxHxD) (cm)	21x18x35
Net wt. (kg)	5.23
Shipping wt. (kg)	8.35

13. COMPLIANCE

Compliance to the following standards is indicated by the corresponding mark on the product.

Marking	Standard
	This product conforms to the EMC directive 2004/108/EC, the Low Voltage Directive 2006/95/EC. The complete Declaration of Conformity is available online at www.ohaus.com .
	AS/NZS 61000.6.1, AS/NZS 61000.6.3
	CAN/CSA C22.2 No. 61010-1, UL Std No. 61010-1

FCC Note

This equipment has been tested and found to comply with the limits for a Class A digital device, pursuant to Part 15 of the FCC Rules. These limits are designed to provide reasonable protection against harmful interference when the equipment is operated in a commercial environment. This equipment generates, uses, and can radiate radio frequency energy and, if not installed and used in accordance with the instruction manual, may cause harmful interference to radio communications. Operation of this equipment in a residential area is likely to cause harmful interference in which case the user will be required to correct the interference at his own expense.

Please note that changes or modifications not expressly approved by the party responsible for compliance could void the user's authority to operate the equipment.

Industry Canada Note

This Class A digital apparatus complies with Canadian ICES-003.

ISO 9001 Registration

In 1994, Ohaus Corporation, USA, was awarded a certificate of registration to ISO 9001 by Bureau Veritas Quality International (BVQI), confirming that the Ohaus quality management system is compliant with the ISO 9001 standard's requirements. On May 21, 2009, Ohaus Corporation, USA, was re-registered to the ISO 9001:2008 standard.

Disposal



In conformance with the European Directive 2002/96/EC on Waste Electrical and Electronic Equipment (WEEE) this device may not be disposed of in domestic waste. This also applies to countries outside the EU, per their specific requirements.

The Batteries Directive 2006/66/EC introduces new requirements from September 2008 on removability of batteries from waste equipment in EU Member States. To comply with this Directive, this device has been designed for safe removal of the batteries at end-of-life by a waste treatment facility.

Please dispose of this product in accordance with local regulations at the collecting point specified for electrical and electronic equipment.

If you have any questions, please contact the responsible authority or the distributor from which you purchased this device.

Should this device be passed on to other parties (for private or professional use), the content of this regulation must also be related.

For disposal instructions in Europe, refer to www.ohaus.com/weee
Thank you for your contribution to environmental protection.



Ohaus Corporation
7 Campus Drive
Suite 310
Parsippany, NJ 07054 USA
Tel: (973) 377-9000,
Fax: (973) 944 -7177

www.ohaus.com

With offices worldwide.



P/N 30246849 D © 2017 Ohaus Corporation, all rights reserved.

Printed in China